

Dell™ OptiPlex™ SX270 Systems User's Guide

Documentation for Your Computer

[Finding Information for Your Computer](#)
[Technical Specifications](#)
[System Board Components](#)
[Cleaning Your Computer](#)

About Your Computer

[Front View](#)
[Back View](#)
[Back-Panel Connectors](#)
[Inside Your Computer](#)
[Orientations](#)
[Chassis Stand](#)
[Cable Cover](#)
[Mounting Plate](#)
[Connecting the Power Adapter](#)

Computer and Software Problems

[Solving Problems](#)
[Advanced Troubleshooting](#)
[Getting Help](#)

Advanced Features

[LegacySelect Technology Control](#)
[Manageability](#)
[Security](#)
[Password Protection](#)
[System Setup](#)
[Booting to a USB Device](#)
[Jumper Settings](#)
[Power Button](#)
[Power Management](#)
[Hyper-Threading](#)



Adding and Removing Parts

[Removing the Computer Cover](#)
[Battery](#)
[Module Bay](#)
[Hard Drive](#)
[Memory](#)
[Microprocessor](#)
[Replacing the Computer Cover](#)

Additional Information

[Microsoft® Windows® XP Features](#)
[Glossary](#)
[CAUTION: Safety Instructions](#)
[Ergonomic Computing Habits](#)
[Regulatory Notices](#)
[Warranty and Return Policy](#)

Notes, Notices, and Cautions

-  **NOTE:** A NOTE indicates important information that helps you make better use of your computer.
-  **NOTICE:** A NOTICE indicates either potential damage to hardware or loss of data and tells you how to avoid the problem.
-  **CAUTION:** A CAUTION indicates a potential for property damage, personal injury, or death.

Dell recommends that the original version (Gold) of Windows XP should not be installed on this platform.

Abbreviations and Acronyms

For a complete list of abbreviations and acronyms, see the "[Glossary](#)."

If you purchased a Dell™ n Series computer, any references in this document to Microsoft® Windows® operating systems are not applicable.

Information in this document is subject to change without notice.
© 2003 Dell Computer Corporation. All rights reserved.

Reproduction in any manner whatsoever without the written permission of Dell Computer Corporation is strictly forbidden.

Trademarks used in this text: *Dell*, the *DELL* logo, *OptiPlex*, *Inspiron*, *Dimension*, *Latitude*, *Dell Precision*, *DellNet*, *Dell Travellite*, and *Dell OpenManage* are trademarks of Dell Computer Corporation; *Intel*, *Pentium*, and *Celeron* are registered trademarks of Intel Corporation; *Microsoft*, *Windows NT*, *MS-DOS*, and *Windows* are registered trademarks of Microsoft Corporation; *IBM* and *OS/2* are registered trademarks of International Business Machines Corporation; *Bluetooth* is a trademark owned by Bluetooth SIG, Inc. and is used by Dell Computer Corporation under license; *ENERGY STAR* is a registered trademark of the U.S. Environmental Protection Agency. As an ENERGY STAR Partner, Dell Computer Corporation has determined that this product meets the ENERGY STAR guidelines for energy efficiency.

Other trademarks and trade names may be used in this document to refer to either the entities claiming the marks and names or their products. Dell Computer Corporation disclaims any proprietary interest in trademarks and trade names other than its own.

Model: DCT

March 2003 P/N K0125 Rev. A00

[Back to Contents Page](#)

Regulatory Notices

Dell™ OptiPlex™ SX270 Systems User's Guide

- [FCC Notices \(U.S. Only\)](#)
- [IC Notice \(Canada Only\)](#)
- [CE Notice \(European Union\)](#)
- [ENERGY STAR® Compliance](#)
- [Simplified Chinese Class A Warning Notice \(China Only\)](#)
- [FN 55022 Compliance \(Czech Republic Only\)](#)
- [VCCI Notice \(Japan Only\)](#)
- [MIC Notice \(Republic of Korea Only\)](#)
- [Polish Center for Testing and Certification Notice](#)
- [BSMI Notice \(Taiwan Only\)](#)
- [NOM Information \(Mexico Only\)](#)

Electromagnetic Interference (EMI) is any signal or emission, radiated in free space or conducted along power or signal leads, that endangers the functioning of a radio navigation or other safety service or seriously degrades, obstructs, or repeatedly interrupts a licensed radio communications service. Radio communications services include but are not limited to AM/FM commercial broadcast, television, cellular services, radar, air-traffic control, pager, and Personal Communication Services (PCS). These licensed services, along with unintentional radiators such as digital devices, including computer systems, contribute to the electromagnetic environment.

Electromagnetic Compatibility (EMC) is the ability of items of electronic equipment to function properly together in the electronic environment. While this computer system has been designed and determined to be compliant with regulatory agency limits for EMI, there is no guarantee that interference will not occur in a particular installation. If this equipment does cause interference with radio communications services, which can be determined by turning the equipment off and on, you are encouraged to try to correct the interference by one or more of the following measures:

- 1 Reorient the receiving antenna.
- 1 Relocate the computer with respect to the receiver.
- 1 Move the computer away from the receiver.
- 1 Plug the computer into a different outlet so that the computer and the receiver are on different branch circuits.

If necessary, consult a Dell Technical Support representative or an experienced radio/television technician for additional suggestions.

Dell™ computer systems are designed, tested, and classified for their intended electromagnetic environment. These electromagnetic environment classifications generally refer to the following harmonized definitions:

- 1 Class A is typically for business or industrial environments.
- 1 Class B is typically for residential environments.

Information Technology Equipment (ITE), including peripherals, expansion cards, printers, input/output (I/O) devices, monitors, and so on, that are integrated into or connected to the system should match the electromagnetic environment classification of the computer system.

A Notice About Shielded Signal Cables: Use only shielded cables for connecting peripherals to any Dell device to reduce the possibility of interference with radio communications services. Using shielded cables ensures that you maintain the appropriate EMC classification for the intended environment. For parallel printers, a cable is available from Dell. If you prefer, you can order a cable from Dell on the World Wide Web at accessories.us.dell.com/sna/category.asp?category_id=4117.

Most Dell computer systems are classified for Class B environments. However, the inclusion of certain options can change the rating of some configurations to Class A. To determine the electromagnetic classification for your system or device, see the following sections specific for each regulatory agency. Each section provides country-specific EMC/EMI or product safety information.

FCC Notices (U.S. Only)

Most Dell computer systems are classified by the Federal Communications Commission (FCC) as Class B digital devices. To determine which classification applies to your computer system, examine all FCC registration labels located on the bottom, side, or back panel of your computer, on card-mounting brackets, and on the cards themselves. If any one of the labels carries a Class A rating, your entire system is considered to be a Class A digital device. If *all* labels carry an FCC Class B rating as distinguished by either an FCC ID number or the FCC logo, (FCC), your system is considered to be a Class B digital device.

Once you have determined your system's FCC classification, read the appropriate FCC notice. Note that FCC regulations provide that changes or modifications not expressly approved by Dell could void your authority to operate this equipment.

This device complies with Part 15 of the FCC Rules. Operation is subject to the following two conditions:

- 1 This device may not cause harmful interference.
- 1 This device must accept any interference received, including interference that may cause undesired operation.

Class A

This equipment has been tested and found to comply with the limits for a Class A digital device pursuant to Part 15 of the FCC Rules. These limits are designed to provide reasonable protection against harmful interference when the equipment is operated in a commercial environment. This equipment generates, uses, and can radiate radio frequency energy and, if not installed and used in accordance with the manufacturer's instruction manual, may cause harmful interference with radio communications. Operation of this equipment in a residential area is likely to cause harmful interference, in which case you will be required to correct the interference at your own expense.

Class B

This equipment has been tested and found to comply with the limits for a Class B digital device pursuant to Part 15 of the FCC Rules. These limits are designed to provide reasonable protection against harmful interference in a residential installation. This equipment generates, uses, and can radiate radio frequency energy and, if not installed and used in accordance with the manufacturer's instruction manual, may cause interference with radio communications. However, there is no guarantee that interference will not occur in a particular installation. If this equipment does cause harmful interference to radio or television reception, which can be determined by turning the equipment off and on, you are encouraged to try to correct the interference by one or more of the following measures:

- 1 Reorient or relocate the receiving antenna.
- 1 Increase the separation between the equipment and the receiver.
- 1 Connect the equipment into an outlet on a circuit different from that to which the receiver is connected.
- 1 Consult the dealer or an experienced radio/television technician for help.

FCC Identification Information

The following information is provided on the device or devices covered in this document in compliance with FCC regulations:

- 1 Model number: DCT
- 1 Company name:
Dell Computer Corporation
One Dell Way
Round Rock, Texas 78682 USA
512-338-4400

IC Notice (Canada Only)

Most Dell computer systems (and other Dell digital apparatus) are classified by the Industry Canada (IC) Interference-Causing Equipment Standard #3 (ICES-003) as Class B digital devices. To determine which classification (Class A or B) applies to your computer system (or other Dell digital apparatus), examine all registration labels located on the bottom, side, or the back panel of your computer (or other digital apparatus). A statement in the form of "IC Class A ICES-003" or "IC Class B ICES-003" will be located on one of these labels. Note that Industry Canada regulations provide that changes or modifications not expressly approved by Dell could void your authority to operate this equipment.

This Class B (or Class A, if so indicated on the registration label) digital apparatus meets the requirements of the Canadian Interference-Causing Equipment Regulations.

Cet appareil numérique de la Classe B (ou Classe A, si ainsi indiqué sur l'étiquette d'enregistrement) respecte toutes les exigences du Règlement sur le Matériel Brouilleur du Canada.

CE Notice (European Union)

Marking by the symbol  indicates compliance of this Dell computer to the EMC Directive and the Low Voltage Directive of the European Union. Such marking is indicative that this Dell system meets the following technical standards:

Set 1: For standard Dell ITE with AC power supplies

- 1 EN 55022 — "Information Technology Equipment — Radio Disturbance Characteristics — Limits and Methods of Measurement."
- 1 EN 55024 — "Information Technology Equipment - Immunity Characteristics - Limits and Methods of Measurement."
- 1 EN 61000-3-2 — "Electromagnetic Compatibility (EMC) - Part 3: Limits - Section 2: Limits for Harmonic Current Emissions (Equipment Input Current Up to and Including 16 A Per Phase)."
- 1 EN 61000-3-3 — "Electromagnetic Compatibility (EMC) - Part 3: Limits - Section 3: Limitation of Voltage Fluctuations and Flicker in Low-Voltage Supply Systems for Equipment With Rated Current Up to and Including 16 A."
- 1 EN 60950 — "Safety of Information Technology Equipment."

For -48 volt-direct-current (VDC) powered systems, the following set of standards applies. See the "Declaration of Conformity" to determine whether a particular system meets EN 50082-1 or EN 50082-2 requirements.

Set 2: For -48-VDC powered systems

- 1 EN 55022 — "Information Technology Equipment — Radio Disturbance Characteristics — Limits and Methods of Measurement."
- 1 EN 50082-1 — "Electromagnetic Compatibility - Generic Immunity Standard - Part 1: Residential, Commercial and Light Industry."
- 1 EN 50082-2 — "Electromagnetic Compatibility - Generic Immunity Standard - Part 2: Industrial Environment."
- 1 EN 60950 — "Safety of Information Technology Equipment."

NOTE: EN 55022 emissions requirements provide for two classifications:

- 1 Class A is for typical commercial areas.
- 1 Class B is for typical domestic areas.

RF INTERFERENCE WARNING: This is a Class A product. In a domestic environment this product may cause radio frequency (RF) interference, in which case the user may be required to take adequate measures.

This Dell device is classified for use in a typical Class B domestic environment.

A "Declaration of Conformity" in accordance with the preceding directives and standards has been made and is on file at Dell Computer Corporation Products Europe BV, Limerick, Ireland.

ENERGY STAR® Compliance

Certain configurations of Dell computers comply with the requirements set forth by the Environmental Protection Agency (EPA) for energy-efficient computers. If the front panel of your computer bears the ENERGY STAR® Emblem, your original configuration complies with these requirements and all ENERGY STAR® power management features of the computer are enabled.

NOTE: Any Dell computer bearing the ENERGY STAR® Emblem is certified to comply with EPA ENERGY STAR® requirements as configured when shipped by Dell. Any changes you make to this configuration (such as installing additional expansion cards or drives) may increase the computer's power consumption beyond the limits set by the EPA's ENERGY STAR® Computers program.



ENERGY STAR® Emblem

The EPA's ENERGY STAR® Computers program is a joint effort between the EPA and computer manufacturers to reduce air pollution by promoting energy-efficient computer products. The EPA estimates that use of ENERGY STAR® computer products can save computer users up to two billion dollars annually in electricity costs. In turn, this reduction in electricity usage can reduce emissions of carbon dioxide, the gas primarily responsible for the greenhouse effect, and sulfur dioxide and nitrogen oxides, the primary causes of acid rain.

You can also help reduce electricity usage and its side effects by turning off your computer when it is not in use for extended periods of time, particularly at night and on weekends.

Simplified Chinese Class A Warning Notice (China Only)

On Class A systems, the following warning will appear near the regulatory label:

Warning: This is a Class A product. In a domestic environment this product may cause radio interference, in which case the user may be required to take adequate measures.

声明

此为 A 级产品，在生活环境中，该产品可能会造成无线电干扰。
在这种情况下，可能需要用户对其干扰采取切实可行的措施。

EN 55022 Compliance (Czech Republic Only)

This device belongs to Class B devices as described in EN 55022, unless it is specifically stated that it is a Class A device on the specification label. The following applies to devices in Class A of EN 55022 (radius of protection up to 30 meters). The user of the device is obliged to take all steps necessary to remove sources of interference to telecommunication or other devices.

Pokud není na typovém štítku počítače uvedeno, že spadá do třídy A podle EN 55022, spadá automaticky do třídy B podle EN 55022. Pro zařízení zařazená do třídy A (ochranné pásmo 30m) podle EN 55022 platí následující. Dojde-li k rušení telekomunikačních nebo jiných zařízení, je uživatel povinen provést taková opatření, aby rušení odstranil.

VCCI Notice (Japan Only)

Most Dell computer systems are classified by the Voluntary Control Council for Interference (VCCI) as Class B information technology equipment (ITE). However, the inclusion of certain options can change the rating of some configurations to Class A. ITE, including peripherals, expansion cards, printers, input/output (I/O) devices, monitors, and so on, integrated into or connected to the system should match the electromagnetic environment classification (Class A or B) of the computer system.

To determine which classification applies to your computer system, examine the regulatory labels/markings (see "VCCI Class A ITE Regulatory Mark" and "VCCI Class B ITE Regulatory Mark") located on the bottom, side, or back panel of your computer. Once you have determined your system's VCCI classification, read the appropriate VCCI notice.

Class A ITE

この装置は、情報処理装置等電波障害自主規制協議会(VCCI)の基準に基づくクラス A 情報技術装置です。この装置を家庭環境で使用すると電波妨害を引き起こすことがあります。この場合には使用者が適切な対策を講ずるよう要求されることがあります。

This is a Class A product based on the standard of the Voluntary Control Council for Interference (VCCI) for information technology equipment. If this equipment is used in a domestic environment, radio disturbance may arise. When such trouble occurs, the user may be required to take corrective actions.

VCCI Class A ITE Regulatory Mark

If the regulatory label includes the following marking, your computer is a Class A product:

VCCI

Class B ITE

この装置は、情報処理装置等電波障害自主規制協議会(VCCI)の基準に基づくクラス B 情報技術装置です。この装置は家庭環境で使用することを目的としていますが、ラジオやテレビジョン受信機に近接して使用されると、受信障害を引き起こすことがあります。取扱説明書に従って正しい取り扱いをしてください。

This is a Class B product based on the standard of the Voluntary Control Council for Interference (VCCI) for information technology equipment. If this equipment is used near a radio or television receiver in a domestic environment, it may cause radio interference. Install and use the equipment according to the instruction manual.

VCCI Class B ITE Regulatory Mark

If the regulatory label includes the following marking, your computer is a Class B product:



MIC Notice (Republic of Korea Only)

To determine which classification (Class A or B) applies to your computer (or other Dell digital device), examine the Republic of Korean Ministry of Information and Communications (MIC) registration labels located on your computer (or other Dell digital device). The MIC label may be located separately from the other regulatory marking applied to your product. Line two of the label identifies the emissions class for the product—"A" for Class A products or "B" for Class B products.

NOTE: MIC emissions requirements provide for two classifications:

- 1 Class A devices are for business purposes.
- 1 Class B devices are for nonbusiness purposes.

Class A Device

기종별	사용자 안내문
A급 기기 (업무용 정보통신기기)	이 기기는 업무용으로 전자파적합등록을 한 기기이오니 판매자 또는 사용자는 이 점을 주의하시기 바라며 만약 잘못 판매 또는 구입하였을 때에는 가정용으로 교환하시기 바랍니다.

Please note that this device has been approved for business purposes with regard to electromagnetic interference. If you find that this device is not suitable for your use, you may exchange it for a nonbusiness-purpose device.

MIC Class A Regulatory Label

If the regulatory label includes the following marking, your computer is a Class A product:



1. 기기의 명칭(모델명):
2. 인증번호:(A)
3. 인증받은 자의 상호:
4. 제조년월일:
5. 제조자/제조국가:

Class B Device

기종별	사용자 안내문
B급 기기 (가정용 정보통신기기)	이 기기는 가정용으로 전자파적합등록을 한 기기로서 주거지역에서는 물론 모든 지역에서 사용할 수 있습니다.

Please note that this device has been approved for nonbusiness purposes and may be used in any environment, including residential areas.

MIC Class B Regulatory Label

If the regulatory label includes the following marking, your computer is a Class B product.



1. 기기의 명칭(모델명):
2. 인증번호:(B)
3. 인증받은 자의 상호:
4. 제조년월일:
5. 제조자/제조국가:

Polish Center for Testing and Certification Notice

The equipment should draw power from a socket with an attached protection circuit (a 3-prong socket). All equipment that works together (computer, monitor, printer, and so on) should have the same power supply source.

The phasing conductor of the room's electrical installation should have a reserve short-circuit protection device in the form of a fuse with a nominal value no larger than 16 amperes (A).

To completely switch off the equipment, the power supply cable must be removed from the power supply socket, which should be located near the equipment and easily accessible.

A protection mark "B" confirms that the equipment is in compliance with the protection usage requirements of standards PN-93/T-42107 and PN-EN 55022:1996.

Wymagania Polskiego Centrum Badań i Certyfikacji

Urządzenie powinno być zasilane z gniazda z przyłączonym obwodem ochronnym (gniazdo z kolkiem). Współpracujące ze sobą urządzenia (komputer, monitor, drukarka) powinny być zasilane z tego samego źródła.

Instalacja elektryczna pomieszczenia powinna zawierać w przewodzie fazowym rezerwową ochronę przed zwarciami, w postaci bezpiecznika o wartości znamionowej nie większej niż 16A (amperów).

W celu całkowitego wyłączenia urządzenia z sieci zasilania, należy wyjąć wtyczkę kabla zasilającego z gniazdka, które powinno znajdować się w pobliżu urządzenia i być łatwo dostępne. Znak bezpieczeństwa "B" potwierdza zgodność urządzenia z wymaganiami bezpieczeństwa użytkownika zawartymi w *PN-EN 60950:2000 i PN-EN 55022:2000*.

Jeżeli na tabliczce znamionowej umieszczono informację, że urządzenie jest klasy A, to oznacza to, że urządzenie w środowisku mieszkalnym może powodować zakłócenia radioelektryczne. W takich przypadkach można żądać od jego użytkownika zastosowania odpowiednich środków zaradczych.

Pozostałe instrukcje bezpieczeństwa

- Nie należy używać wtyczek adapterowych lub usuwać kolka obwodu ochronnego z wtyczki. Jeżeli konieczne jest użycie przedłużacza to należy użyć przedłużacza 3-żyłowego z prawidłowo połączonym przewodem ochronnym.
- System komputerowy należy zabezpieczyć przed nagłymi, chwilowymi wzrostami lub spadkami napięcia, używając eliminatora przepięć, urządzenia dopasowującego lub bezzakłóceńowego źródła zasilania.
- Należy upewnić się, aby nic nie leżało na kablach systemu komputerowego, oraz aby kable nie były umieszczone w miejscu, gdzie można byłoby na nie nadeptywać lub potykać się o nie.
- Nie należy rozlewać napojów ani innych płynów na system komputerowy.
- Nie należy wpychać żadnych przedmiotów do otworów systemu komputerowego, gdyż może to spowodować pożar lub porażenie prądem, poprzez zwarcie elementów wewnętrznych.
- System komputerowy powinien znajdować się z dala od grzejników i źródeł ciepła. Ponadto, nie należy blokować otworów wentylacyjnych. Należy unikać kładzenia luźnych papierów pod komputer oraz umieszczania komputera w ciasnym miejscu bez możliwości cyrkulacji powietrza wokół niego.

BSMI Notice (Taiwan Only)

If you find a  or  mark on the regulatory

label on the bottom, side, or back panel of your computer, the following section is applicable:

BSMI 通告 (僅限於台灣)

大多數的 Dell 電腦系統被 BSMI (經濟部標準檢驗局) 劃分為乙類數位裝置。但是，使用某些週件會使有些組件的等級變成甲類。若要確定您的電腦系統適用等級，請檢查所有位於電腦底部或背面板、擴充卡安裝托架，以及擴充卡上的 BSMI 註冊標籤。如果其中有一甲類標籤，即表示您的系統為甲類數位裝置。如果只有 BSMI 的檢驗號碼標籤，則表示您的系統為乙類數位裝置。

一旦確定了系統的 BSMI 等級，請閱讀相關的 BSMI 通告。請注意，BSMI 通告規定凡是未經 Dell Computer Corporation 明確核准的擅自變更或修改，將導致您失去此設備的使用權。

此裝置符合 BSMI (經濟部標準檢驗局) 的規定，使用時須符合以下兩項條件：

- 此裝置不會產生有害干擾。
- 此裝置必須能接受所接收到的干擾，包括可能導致無法正常作業的干擾。

甲類

此設備經測試證明符合 BSMI (經濟部標準檢驗局) 之甲類數位裝置的限制規定。這些限制的目的是為了在商業環境中使用此設備時，能提供合理的保護以防止有害的干擾。此設備會產生、使用並散發射頻能量；如果未遵照製造廠商的指導手冊來安裝和使用，可能會干擾無線電通訊。請勿在住宅區使用此設備。

警告使用者：
這是甲類的資訊產品，在居住的環境中使用時，可能會造成射頻干擾，在這種情況下，使用者會被要求採取某些適當的對策。

乙類

此設備經測試證明符合 BSMI (經濟部標準檢驗局) 之乙類數位裝置的限制規定。這些限制的目的是為了在住宅區安裝時，能防止有害的干擾、提供合理的保護。此設備會產生、使用並散發射頻能量；如果未遵照製造廠商的指導手冊來安裝和使用，可能會干擾無線電通訊。但是，這並不保證在個別的安装中不會產生干擾。您可以透過關閉和調整此設備來判斷它是否會對廣播和電視收訊造成干擾；如果確實如此，我們建議您嘗試以下列一種或多種方法來排除干擾：

- 重新調整天線的接收方向或重新放置接收天線。
- 增加設備與接收器的距離。
- 將設備連接至不同的插座，使設備與接收器連接在不同的電路上。
- 請向經銷商或有經驗的無線電/電視技術人員查詢，以獲得幫助。

NOM Information (Mexico Only)

The following information is provided on the device(s) described in this document in compliance with the requirements of the official Mexican standards (NOM):

Exporter:	Dell Computer Corporation One Dell Way Round Rock, TX 78682
Importer:	Dell Computer de México, S.A. de C.V. Paseo de la Reforma 2620 - 11º Piso Col. Lomas Altas 11950 México, D.F.
Ship to:	Dell Computer de México, S.A. de C.V. al Cuidado de Kuehne & Nagel de México S. de R.I. Avenida Soles No. 55 Col. Peñon de los Baños 15520 México, D.F.
Model number:	DCT
Supply voltage:	12 VDC
Input current rating:	12 A

[Back to Contents Page](#)

[Back to Contents Page](#)

Warranty and Return Policy

Dell™ OptiPlex™ SX270 Systems User's Guide

Dell Computer Corporation ("Dell") manufactures its hardware products from parts and components that are new or equivalent to new in accordance with industry-standard practices. For information about the Dell warranty for your computer, see the *Setup and Quick Reference Guide*.

[Back to Contents Page](#)

About Your Computer

Dell™ OptiPlex™ SX270 Systems User's Guide

- [Front View](#)
- [Back View](#)
- [Back-Panel Connectors](#)
- [Inside Your Computer](#)
- [Orientations](#)
- [Chassis Stand](#)
- [Cable Cover](#)
- [Mounting Plate](#)
- [Connecting the Power Adapter](#)

Front View

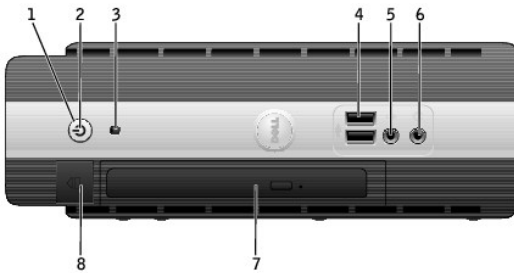

1	power button	Press this button to turn on the computer. NOTICE: To avoid losing data, do not use the power button to turn off the computer. Instead, perform a Microsoft® Windows® shutdown.
2	power light	The power light illuminates and blinks or remains solid to indicate different states: <ul style="list-style-type: none"> 1 No light — The computer is turned off (S4, S5, or mechanical OFF). 1 Steady green — The computer is in a normal operating state. 1 Blinking green — The computer is in a power-saving state (S1 or S3). 1 Blinking or solid amber — See "Power Problems." <p>To exit from a power-saving state, press the power button or use the keyboard or the mouse if it is configured as a wake device in the Windows Device Manager. For more information about sleep states and exiting from a power-saving state, see "Power Management."</p> <p>See "Diagnostic Lights" for a description of light codes that can help you troubleshoot problems with your computer.</p>
3	hard-drive access light	The hard-drive access light is on when the computer reads data from or writes data to the hard drive. The light might also be on when devices such as your CD player are operating.
4	USB connectors (2)	Connect USB devices such as a mouse, keyboard, printer, joystick, and computer speakers into either of the USB connectors.
5	microphone connector	Attach a microphone to this connector.
6	headphone connector	Attach headphones to this connector.
7	module bay	Install a CD/DVD drive, second hard drive, or floppy drive in the module bay.
8	module release button	Press this button to remove a device in the module bay.

Back View

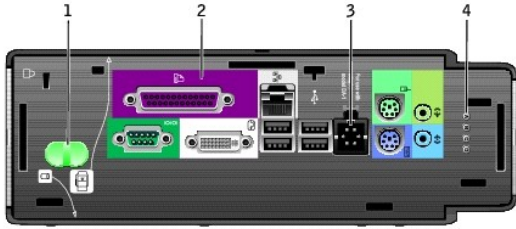

1	computer cover/hard-drive release button	Press this button toward the cover release icon to remove the cover, or press this button toward the hard-drive icon to release the hard drive.
2	back-panel connectors	The connectors for your computer.
3	power connector	The connector for the power adapter.
4	diagnostic lights	See " Diagnostic Lights " for a description of light codes that can help you troubleshoot problems with your computer.

Back-Panel Connectors

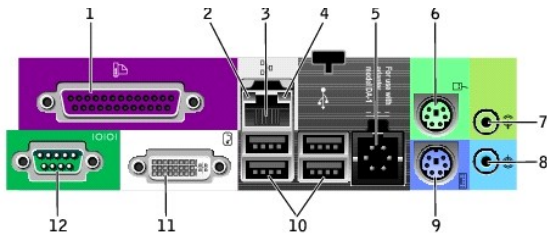

1	parallel connector	Connect a parallel device, such as a printer, to the parallel connector. If you have a USB printer, plug it into a USB connector.
2	link integrity light	<ul style="list-style-type: none"> 1 Green — A good connection exists between a 10-Mbps network and the computer. 1 Orange — A good connection exists between a 100-Mbps network and the computer. 1 Yellow — A good connection exists between a 1000-Mbps (1-Gbps) network and the computer. 1 Off — The computer is not detecting a physical connection to the network or the Network Controller is turned off in system setup.
3	network adapter	<p>Attach the UTP cable to an RJ45 jack wall plate or to an RJ45 port on a UTP concentrator or hub and press the other end of the UTP cable into the network adapter connector until the cable snaps securely into place.</p> <p>Dell recommends the use of Category 5 wiring and connectors for our customers' networks.</p>
4	network activity light	The yellow light flashes when the computer is transmitting or receiving network data. A high volume of network traffic may make this light appear to be in a steady "on" state.
5	power connector	The connector for the power adapter.
6	mouse connector	<p>Plug a standard mouse into the green mouse connector. Turn off the computer and any attached devices before you connect a mouse to the computer. If you have a USB mouse, plug it into a USB connector.</p> <p>If your computer is running Windows 2000 or Windows XP, Dell installed the necessary mouse drivers on your hard drive.</p>
7	line-out connector	Use the green line-out connector to attach an amplified speaker set.
8	line-in connector	Use the blue line-in connector to attach a record/playback device such as a cassette player, CD player, or VCR.
9	keyboard connector	If you have a standard keyboard, plug it into the purple keyboard connector. If you have a USB keyboard, plug it into a USB connector.
10	USB connectors (4)	Connect USB devices such as a mouse, keyboard, printer, joystick, and computer speakers into any of the USB connectors.
11	video connector	<p>If you have a DVI-compatible monitor, plug the cable from your monitor into the white connector on the back panel.</p> <p>If you have a VGA monitor, see "Connecting a VGA Monitor."</p>
12	serial connector	Connect a serial device, such as a handheld device, to the serial connector.

Connecting a VGA Monitor

If you have a VGA Monitor, plug the VGA-DVI adapter into the DVI connector and connect the monitor cable to the adapter as shown.

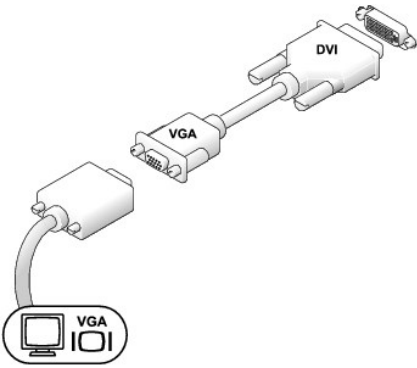

Inside Your Computer

- ⚠ **CAUTION:** Before you remove the computer cover, follow the steps in "[CAUTION: Safety Instructions.](#)"
- ⚠ **CAUTION:** To avoid electrical shock, always unplug your computer from the power adapter before removing the cover.
- ⚠ **CAUTION:** To prevent static damage to components inside your computer, discharge static electricity from your body before you touch any of your computer's electronic components. You can do so by touching an unpainted metal surface on the computer chassis.

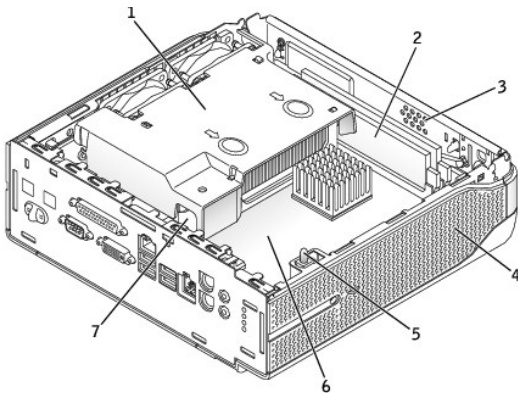

1	microprocessor heat sink fan shroud	5	chassis intrusion switch
2	memory modules	6	system board
3	speaker (optional)	7	battery
4	cooling vents		

Orientations

The computer can be used in either a vertical or horizontal position on a desktop or mounted under a surface such as a desk or table. By using a wall-mount bracket, the computer may be attached to a wall.

- 🔍 **NOTICE:** When setting up your computer, secure all cables toward the back of your work area to prevent the cables from being pulled, tangled, or stepped on.

Standard Orientations

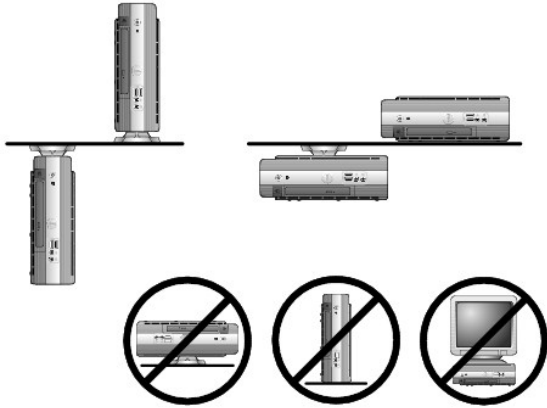

- ➔ **NOTICE:** Do not place your monitor on the computer. Use a monitor stand.
- ➔ **NOTICE:** In a high-vibration environment or when installing the computer overhead, use the optional wall-mount bracket instead of the chassis stand. To order this bracket, [contact Dell](#).
- ➔ **NOTICE:** To ensure proper ventilation, do not place your computer vertically on a desktop without using the chassis stand (see "[Chassis Stand](#)").
- ➔ **NOTICE:** To ensure proper ventilation, do not block the cooling vents.

As an option, you may mount the computer to a vertical or horizontal surface by using a wall-mount bracket. If you have the integrated flat-panel option, the stand is integrated as part of the total assembly.



Chassis Stand

You may attach the chassis stand to orient your computer vertically. You can also attach the stand to the mounting plate (see "[Mounting Plate](#)") to hang the computer under a tabletop or desktop or to securely attach the computer to a horizontal surface.

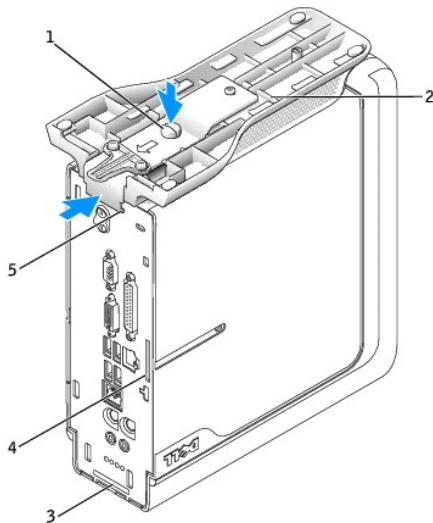
1. Raise the captive screw and slide the chassis stand slat into one of three mounting slots on the back of the computer.
2. When the stand is in place, tighten the screw.



1	captive screw
2	chassis stand

3	mounting slot (for vertical position, upright on a desktop)	
4	mounting slot (for horizontal position hanging under a desktop) NOTE: The stand must not be used in the horizontal position on a desktop. Place the computer directly on a desktop.	
5	mounting slot (for vertical position, hanging under a surface)	

To remove the chassis stand, loosen and lift the screw. Hold the screw up while sliding the stand out of the slot.

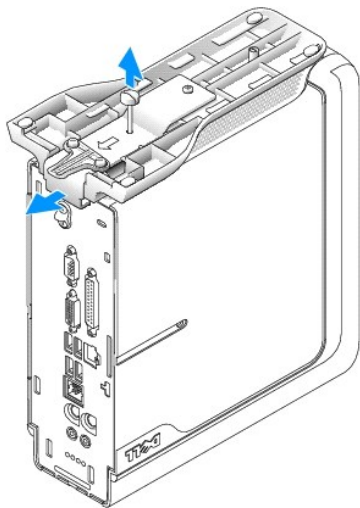

Cable Cover

- ➡ **NOTE:** If you are installing the computer under a desktop or tabletop, do not attach the cable cover until the computer is firmly attached to the mounting plate (see "[Attaching the Computer to the Mounting Plate](#)").

Attaching the Cable Cover

- 🔧 **NOTE:** If you use the stand on your computer, attach the stand before attaching the cable cover.

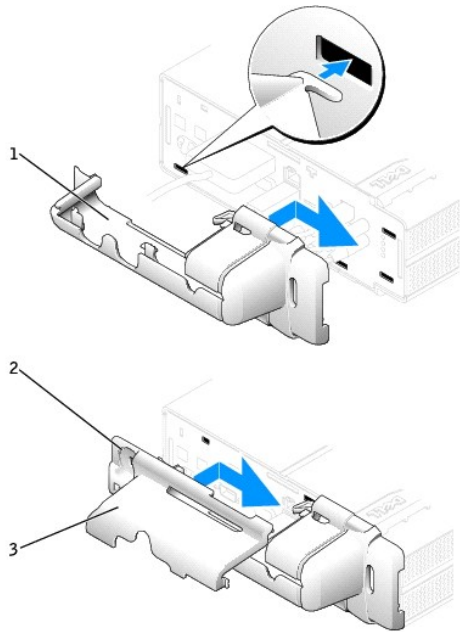

1	bottom piece of the cable cover
2	security cable slot
3	top piece of the cable cover

1. Attach all the cables to the back panel.
2. To attach the two-piece cable cover, hold the bottom piece of the cable cover and align the four tabs with the four slots on the computer's back panel.
3. Insert the tabs into the slots and slide the piece toward the diagnostic lights (see the illustration) until it is securely positioned.
4. Grasp the top piece of the cable cover and align the two tabs with the two slots in the computer's back panel.
5. Insert the tabs into the slots and slide the piece toward the diagnostic lights (see the illustration).
6. Install a security device in the security cable slot (optional).

Removing the Cable Cover

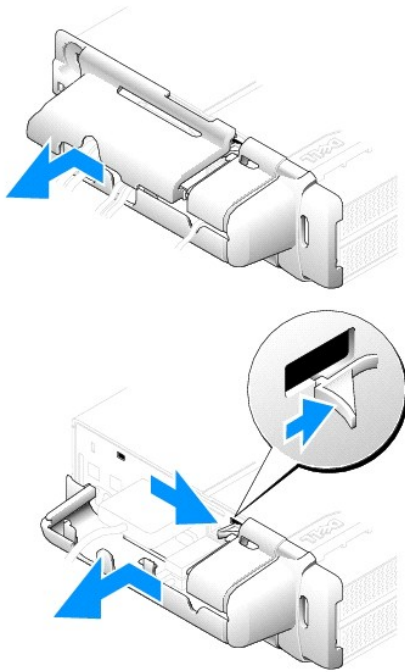



1. If a security device is installed in the security cable slot, remove the device.
2. Grasp the top piece of the cable cover and slide it to the left until it stops, and then lift it up and away.
3. To remove the bottom piece of the cable cover, while pressing the lever, slide the piece to the left until it stops, and then lift it up and away.

Mounting Plate

 **NOTICE:** When installing the computer in the hanging orientation, avoid locations where it will be bumped by a user's legs or chair.

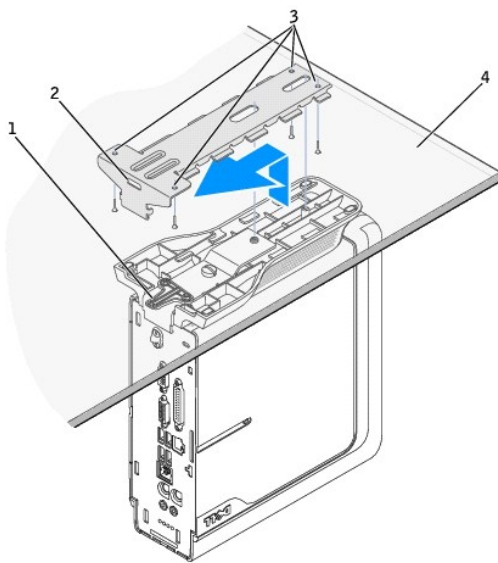
Attaching the Computer to the Mounting Plate



 **NOTE:** Before attaching the mounting plate to a surface, first orient yourself with how the stand attaches to the mounting plate.

1	release lever tab
2	mounting plate slot
3	screw holes (4)
4	solid surface with a 1-inch (2.5 cm) minimum thickness

⚠ CAUTION: Attach the mounting plate to a solid surface capable of supporting 40 lbs (18.1 kg) hanging weight.

1. Using the four #6 wood screws (0.625 inch; 15.88 mm) provided, attach the mounting plate to a solid surface with a minimum thickness of 1 inch (2.5 cm).
2. Orient the computer and stand under the mounting plate approximately 1 inch (2.5 cm) from the edge of the mounting plate.
3. Lift the computer and stand, insert the stand into the mounting bracket, and slide the stand until the release lever tab is inserted through the slot in the mounting plate.

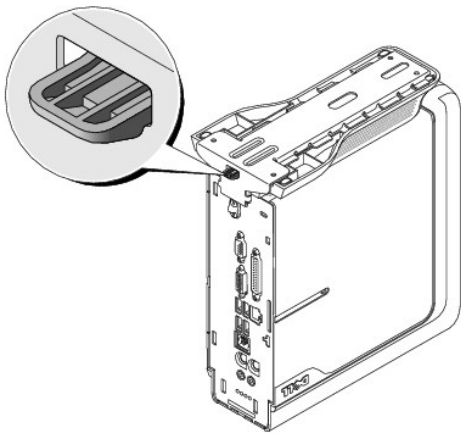

4. Attach the cable cover (if used).

Removing the Computer From the Mounting Plate

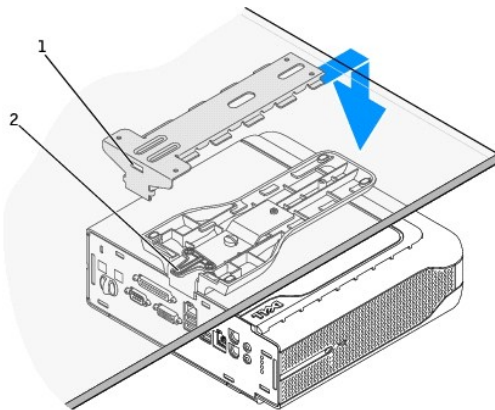

1	mounting plate slot
2	release lever tab

⚠ CAUTION: To avoid personal injury, remove the mounting plate if you are permanently removing the computer.

1. Firmly hold the computer and press the release lever tab until the tab is freed from the slot on the mounting plate.

2. While still firmly holding the computer, slide the computer and stand approximately 1 inch (2.5 cm), until it stops.
3. Lower the computer and stand away from the mounting plate.

Connecting the Power Adapter

1. Connect the power adapter to the connector on the back of the computer. In order for the connection to be secure, verify that the latch engages completely (a click will be heard or felt).
2. Connect a power cable to the power adapter.

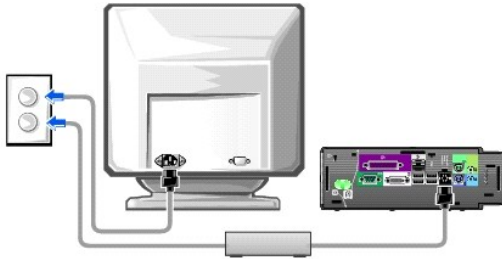

 **NOTICE:** The following section applies to Japan only.

 **CAUTION:** If you decide to connect the green ground wire to an electrical outlet, *do not permit* contact between the green ground wire and power leads because electrical shock, fire, or damage to your computer can occur (see the following illustration).



If you decide *not* to connect the green ground wire to an electrical outlet, go to [step 4](#).

3. Connect the metal ground connector to the grounding source on the outlet (see the following illustration):
 - a. Loosen the grounding source.
 - b. Slide the metal ground connector behind the grounding source, and then tighten the grounding source.

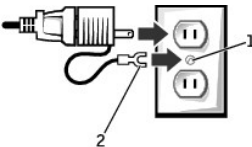

1	grounding source
2	metal ground connector

4. Connect the power cable to the outlet.

[Back to Contents Page](#)

Advanced Troubleshooting

Dell™ OptiPlex™ SX270 Systems User's Guide

- [Dell Diagnostics](#)
 - [Drivers](#)
 - [Reinstalling Microsoft® Windows® XP](#)
 - [Reinstalling Microsoft Windows 2000](#)
 - [Resolving Software and Hardware Incompatibilities](#)
-

Dell Diagnostics

When to Use the Dell Diagnostics

If you experience a problem with your computer, perform the checks in "[Solving Problems](#)" and run the Dell Diagnostics before you contact Dell for technical assistance. Running the Dell Diagnostics may help you resolve the problem without contacting Dell. If you do contact Dell, the test results can provide important information for Dell's service and support personnel.

The Dell Diagnostics allows you to:

- 1 Perform tests on one or all devices.
- 1 Select tests based on a symptom of the problem you are having.
- 1 Choose how many times a test is run.
- 1 Suspend testing if an error is detected.
- 1 Access help information that describes the tests and devices.
- 1 Receive status messages that tell you whether tests completed successfully.
- 1 Receive error messages if problems are detected.

Starting the Dell Diagnostics

It is recommended that you print these procedures before you begin.

 **NOTICE:** Use the Dell Diagnostics to test your Dell™ computer only. Using this program with other computers can result in error messages.

Enter [system setup](#), review your computer's configuration information, and ensure that the device you want to test displays in system setup and is active.

Start the Dell Diagnostics from either your hard drive or from the *Drivers and Utilities* CD (also known as the ResourceCD).

Starting the Dell Diagnostics From Your Hard Drive

1. Shut down and restart the computer.
2. When the DELL™ logo appears, press <F12> immediately.

 **NOTE:** If you see a message stating that no diagnostics utility partition has been found, run the Dell Diagnostics from your *Drivers and Utilities* CD.

If you wait too long and the Microsoft® Windows® logo appears, continue to wait until you see the Windows desktop. Then shut down your computer through the **Start** menu and try again.

3. When the boot device list appears, highlight **Boot to Utility Partition** and press <Enter>.
4. When the Dell Diagnostics **Main Menu** appears, select the test you want to run.

Starting the Dell Diagnostics From the Drivers and Utilities CD

1. Insert the *Drivers and Utilities* CD.
2. Shut down and restart the computer.

When the DELL logo appears, press <F12> immediately.

If you wait too long and the Windows logo appears, continue to wait until you see the Windows desktop. Then shut down your computer through the **Start** menu and try again.

 **NOTE:** This feature changes the boot sequence for one time only. On the next start-up, the computer boots according to the devices specified in system setup.

3. When the boot device list appears, highlight **IDE CD-ROM Device** and press <Enter>.

4. Select the **IDE CD-ROM Device** option from the CD boot menu.
5. Select the **Boot from CD-ROM** option from the menu that appears.
6. Type 1 to start the ResourceCD menu.
7. Type 2 to start the Dell Diagnostics.
8. Select **Run the 32 Bit Dell Diagnostics** from the numbered list. If multiple versions are listed, select the version appropriate for your computer.
9. When the Dell Diagnostics **Main Menu** appears, select the test you want to run.

Dell Diagnostics Main Menu

1. After the Dell Diagnostics loads and the **Main Menu** screen appears, click the button for the option you want.

Option	Function
Express Test	Performs a quick test of devices. This test typically takes 10 to 20 minutes and requires no interaction on your part. Run Express Test first to increase the possibility of tracing the problem quickly.
Extended Test	Performs a thorough check of devices. This test typically takes an hour or more and requires you to answer questions periodically.
Custom Test	Tests a specific device. You can customize the tests you want to run.
Symptom Tree	Lists the most common symptoms encountered and allows you to select a test based on the symptom of the problem you are having.

2. If a problem is encountered during a test, a message appears with an error code and a description of the problem. Write down the error code and problem description and follow the instructions on the screen.

If you cannot resolve the error condition, [contact Dell](#).

 **NOTE:** The Service Tag for your computer is located at the top of each test screen. If you contact Dell, technical support will ask for your Service Tag number.

3. If you run a test from the **Custom Test** or **Symptom Tree** option, click the applicable tab described in the following table for more information.

Tab	Function
Results	Displays the results of the test and any error conditions encountered.
Errors	Displays error conditions encountered, error codes, and the problem description.
Help	Describes the test and may indicate requirements for running the test.
Configuration	Displays your hardware configuration for the selected device. The Dell Diagnostics obtains configuration information for all devices from system setup, memory, and various internal tests, and it displays the information in the device list in the left pane of the screen. The device list may not display the names of all the components installed on your computer or all devices attached to your computer.
Parameters	Allows you to customize the test by changing the test settings.

4. When the tests are completed, if you are running the Dell Diagnostics from the *Drivers and Utilities* CD, remove the CD.
5. Close the test screen to return to the **Main Menu** screen. To exit the Dell Diagnostics and restart the computer, close the **Main Menu** screen.

Drivers

What Is a Driver?

A driver is a program that controls a device such as a printer, mouse, or keyboard. All devices require a driver program.

A driver acts like a translator between the device and any other programs that use the device. Each device has its own set of specialized commands that only its driver recognizes.

Dell ships your computer to you with required drivers already installed—no further installation or configuration is needed.

 **NOTICE:** The *Drivers and Utilities* CD may contain drivers for operating systems that are not on your computer. Ensure that you are installing software appropriate for your operating system.

Many drivers, such as the keyboard driver, come with your Microsoft® Windows® operating system. You may need to install drivers if you:

- 1 Upgrade your operating system.
- 1 Reinstall your operating system.
- 1 Connect or install a new device.

Identifying Drivers

If you experience a problem with any device, identify whether the driver is the source of your problem and, if necessary, update the driver.

Windows XP

1. Click the **Start** button and click **Control Panel**.
2. Under **Pick a Category**, click **Performance and Maintenance**.
3. Click **System**.
4. In the **System Properties** window, click the **Hardware** tab.
5. Click **Device Manager**.
6. Scroll down the list to see if any device has an exclamation point (a yellow circle with a [!]) on the device icon.

If an exclamation point is next to the device name, you may need to reinstall the driver or install a new driver (see "[Reinstalling Drivers and Utilities](#)")."

Windows 2000

1. Click the **Start** button, point to **Settings**, and then click **Control Panel**.
2. Double-click **System**.
3. In the **System Properties** window, click the **Hardware** tab.
4. Click **Device Manager**.
5. Scroll down the list to see if any device has an exclamation point (a yellow circle with a [!]) on the device icon.

If an exclamation point is next to the device name, you may need to reinstall the driver or install a new driver.

Reinstalling Drivers and Utilities



NOTICE: The Dell Support website at support.dell.com and your *Drivers and Utilities* CD provide approved drivers for Dell™ computers. If you install drivers obtained from other sources, your computer might not work correctly.

Using Windows XP Device Driver Rollback

If a problem occurs on your computer after you install or update a driver, use Windows XP Device Driver Rollback to replace the driver with the previously installed version.

1. Click the **Start** button and click **Control Panel**.
2. Under **Pick a Category**, click **Performance and Maintenance**.
3. Click **System**.
4. In the **System Properties** window, click the **Hardware** tab.
5. Click **Device Manager**.
6. Right-click the device for which the new driver was installed and click **Properties**.
7. Click the **Drivers** tab.
8. Click **Roll Back Driver**.

If Device Driver Rollback does not resolve the problem, then use [System Restore](#) to return your computer to the operating state that existed before you installed the new driver.

Using the Drivers and Utilities CD

If using Device [Driver Rollback](#) or [System Restore](#) does not resolve the problem, then reinstall the driver from the *Drivers and Utilities* CD (also known as the ResourceCD).



NOTE: To access device drivers and user documentation, you must use the *Drivers and Utilities* CD while your computer is running Windows.

1. Insert the *Drivers and Utilities* CD.

If this is your first time to use the *Drivers and Utilities* CD, the **Installation** window opens to inform you that the CD will begin the installation. Click **OK** and respond to the installation program prompts to complete the installation.

2. Click **Next** at the **Welcome Dell System Owner** screen.
3. Choose the appropriate selections for **System Model**, **Operating System**, **Device Type**, and **Topic**.
4. Click **My Drivers** in the **Topic** drop-down menu.

The *Drivers and Utilities* CD scans your computer's hardware and operating system and then displays a list of device drivers for your system configuration.

5. Click the appropriate driver and follow the instructions to download the driver for your computer.

To view a list of all available drivers for your computer, click **Drivers** in the **Topic** drop-down menu.

To access the help files on the *Drivers and Utilities* CD, click the question mark button or the **Help** link at the top of the screen.

Reinstalling Microsoft Windows XP

Before You Reinstall

 **NOTICE:** Before performing the installation, back up all data files on your primary hard drive. For conventional hard drive configurations, the primary hard drive is the first drive detected by the computer.

To reinstall Windows XP, you need the following items:

- 1 Dell *Operating System* CD
- 1 Dell *ResourceCD*

 **NOTE:** The Dell *ResourceCD* contains drivers that were factory-installed during assembly of the computer. Use the ResourceCD to load any required drivers, including those drivers required if your computer has a redundant array of independent disks (RAID) controller.

- 1 Product Key (Product ID Number) _____

 **NOTE:** The Product Key is the bar code number on the sticker that is located on the external side cover of your computer. You may be prompted for the Product Key when using the *Operating System* CD under certain conditions.

Reinstalling Windows XP

To reinstall Windows XP, perform all the steps in the following sections in the order in which they are listed.

The reinstallation process can take 1 to 2 hours to complete. After you reinstall the operating system, you must also reinstall the device drivers, virus protection program, and other software.

 **NOTICE:** The *Operating System* CD provides options for reinstalling Windows XP. The options can overwrite files and possibly affect programs installed on your hard drive. Therefore, do not reinstall Windows XP unless instructed to do so by a Dell technical support representative.

 **NOTICE:** To prevent conflicts with Windows XP, disable any virus protection software installed on your computer before you reinstall Windows XP. See the documentation that came with the software for instructions.

Booting From the Operating System CD

1. Save and close any open files and exit any open programs.
2. Insert the *Operating System* CD. If any program starts automatically, exit the program before proceeding.
3. Shut down the computer through the **Start** menu and restart the computer.
4. Press <F12> immediately after the DELL™ logo appears.

If the operating system logo appears, wait until you see the Windows desktop, and then shut down the computer and try again.

5. Press the arrow keys to select **CD-ROM**, and then press <Enter>.
6. When the **Press any key to boot from CD** message appears, press any key.

Windows XP Setup

1. When the **Windows XP Setup** screen appears, press <Enter> to select **To set up Windows now**.
2. Read the information on the **Microsoft Windows Licensing Agreement** screen, and press <F8> to accept the license agreement.
3. If your computer already has Windows XP installed and you want to recover your current Windows XP data, type **r** to select the repair option, and then remove the CD from the drive.
4. If you want to install a new copy of Windows XP, press <Esc> to select that option.
5. Press <Enter> to select the highlighted partition (recommended), and then follow the instructions on the screen.

The **Windows XP Setup** screen appears, and the operating system begins to copy files and install the devices. The computer automatically restarts multiple times.

 **NOTE:** The time required to complete the setup depends on the size of the hard drive and the speed of your computer.

 **NOTICE:** Do not press any key when the following message appears: **Press any key to boot from the CD**.

6. When the **Regional and Language Options** screen appears, select the settings for your location, and then click **Next**.
7. Enter your name and organization (optional) in the **Personalize Your Software** screen and click **Next**.
8. *If you are reinstalling Windows XP Home Edition*, at the **What's your computer's name** window, enter a name for your computer (or accept the name provided) and click **Next**.

If you are reinstalling Windows XP Professional, at the **Computer Name and Administrator Password** window, enter a name for your computer (or accept the one provided) and a password, and then click **Next**.

9. If the **Modem Dialing Information** screen appears, enter the requested information and click **Next**.
10. Enter the date, time, and time zone in the **Date and Time Settings** window and click **Next**.
11. If the **Networking Settings** screen appears, click **Typical** and click **Next**.
12. If you are reinstalling Windows XP Professional and you are prompted to provide further information regarding your network configuration, enter your selections. If you are unsure of your settings, accept the default selections.

Windows XP installs the operating system components and configures the computer. The computer automatically restarts.

 **NOTICE:** Do not press any key when the following message appears: *Press any key to boot from the CD.*

13. When the Welcome to Microsoft screen appears, click **Next**.
14. When the **How will this computer connect to the Internet?** message appears, click **Skip**.
15. When the **Ready to register with Microsoft?** screen appears, select **No, not at this time** and click **Next**.
16. When the **Who will use this computer?** screen appears, you can enter up to five users. Click **Next**.
17. Click **Finish** to complete the setup, and remove the CD from the drive.
18. Reinstall the appropriate drivers using the *ResourceCD*.
19. Reinstall your virus protection software.

Reinstalling Microsoft Windows 2000

 **NOTICE:** The *Operating System* CD provides options for reinstalling Windows XP. The options can overwrite files and possibly affect programs installed on your hard drive. Therefore, do not reinstall Windows XP unless instructed to do so by a Dell technical support representative.

The reinstallation process can take 1 to 2 hours to complete. After you reinstall the operating system, you must also reinstall the device drivers, virus protection program, and other software.

1. Save and close any open files and exit any open programs.
2. Insert the *Operating System* CD. If any program starts automatically, exit the program before proceeding.
3. Shut down the computer through the **Start** menu and restart the computer.
4. Press <F12> immediately after the DELL™ logo appears.

If the operating system logo appears, wait until you see the Windows desktop, and then shut down the computer and try again.

5. Press the arrow keys to select **CD-ROM**, and then press <Enter>.
6. When the *Press any key to boot from CD* message appears, press any key.
7. When the **Windows 2000 Setup** window appears, ensure that **To setup Win2000 now, press ENTER** is highlighted. Then press <Enter>.
8. When the **Windows 2000 Professional Setup** window appears, press the arrow keys to select the Windows 2000 partition option that you want. Then press the key for the partition option you chose.
9. When the **Windows 2000 Professional Setup** window reappears, press the arrow keys to select the type of file system that you want Windows 2000 to use, and then press <Enter>.
10. Press <Enter> again to restart your computer.
11. Click **Next** when the **Welcome to the Windows 2000 Setup Wizard** window appears.
12. When the **Regional Settings** window appears, select your region, and then click **Next**.
13. Enter your name and organization in the **Personalize Your Software** window, and then click **Next**.
14. Enter the Windows product key, which is printed on the Microsoft label on your computer. Then click **Next**.
15. When the **Computer Name and Administrator Password** window appears, enter a name for your computer and a password, if desired. Then click **Next**.
16. Enter the date and time in the **Date and Time Settings** window, and then click **Next**.

Windows 2000 installs components and configures the computer.

17. When the **Completing the Windows 2000 Setup Wizard** window appears, remove the CD from the drive, and then click **Finish**.

The computer automatically restarts.

18. Reinstall the appropriate drivers using the *Drivers and Utilities* CD.

19. Reinstall your virus protection software.

Resolving Software and Hardware Incompatibilities

If a device is either not detected during the operating system setup or is detected but incorrectly configured, you can use Device Manager or the Hardware Troubleshooter to resolve the incompatibility.

Microsoft® Windows® XP

To resolve incompatibilities using Device Manager:

1. Click the **Start** button and click **Control Panel**.
2. Click **Performance and Maintenance** and click **System**.
3. Click the **Hardware** tab and click **Device Manager**.
4. In the **Device Manager** list, check for devices that are incorrectly configured.

Incorrectly configured devices are indicated by a yellow exclamation point (!) or a red x if the device has been disabled.

5. Double-click any device marked with an exclamation point to display the **Properties** window.

The **Device** status area in the **Properties** window reports the cards or devices that need to be reconfigured.

6. Reconfigure the devices or remove the devices from the **Device Manager**. See the documentation that came with the device for information on configuring the device.

To resolve incompatibilities using the Windows XP Hardware Troubleshooter:

1. Click the **Start** button and click **Help and Support**.
2. Type `hardware troubleshooter` in the **Search** field and click the arrow to start the search.
3. Click **Hardware Troubleshooter** in the **Search Results** list.
4. In the **Hardware Troubleshooter** list, click **I need to resolve a hardware conflict on my computer**, and click **Next**.

Windows 2000

To resolve incompatibilities using Device Manager:

1. Click the **Start** button, point to **Settings**, and then click **Control Panel**.
2. In the **Control Panel** window, double-click **System**.
3. Click the **Hardware** tab.
4. Click **Device Manager**.
5. Click **View** and click **Resources by connection**.
6. Double-click **Interrupt request (IRQ)**.

Incorrectly configured devices are indicated by a yellow exclamation point (!) or a red x if the device has been disabled.

7. Double-click any device marked with an exclamation point to display the **Properties** window.

The **Device** status area in the **Properties** window reports the cards or devices that need to be reconfigured.

8. Reconfigure the devices or remove the devices from the Device Manager. See the documentation that came with the device for information on configuring the device.

To resolve incompatibilities using the Windows 2000 Hardware Troubleshooter:

1. Click the **Start** button and click **Help**.
2. Click **Troubleshooting and Maintenance** on the **Contents** tab, click **Windows 2000 troubleshooters**, and then click **Hardware**.
3. In the **Hardware Troubleshooter** list, click **I need to resolve a hardware conflict on my computer** and click **Next**.

[Back to Contents Page](#)

[Back to Contents Page](#)

Advanced Features

Dell™ OptiPlex™ SX270 Systems User's Guide

- [LegacySelect Technology Control](#)
- [Manageability](#)
- [Security](#)
- [Password Protection](#)
- [System Setup](#)
- [Booting to a USB Device](#)
- [Jumper Settings](#)
- [Power Button](#)
- [Power Management](#)
- [Hyper-Threading](#)

LegacySelect Technology Control

LegacySelect technology control offers legacy-full, legacy-reduced, or legacy-free solutions based on common platforms, hard-drive images, and help desk procedures. Control is provided to the administrator through system setup, Dell OpenManage™ IT Assistant, or Dell™ custom factory integration.

LegacySelect allows administrators to electronically activate or deactivate connectors and media devices that include serial and USB connectors, a parallel connector, a floppy drive, and a PS/2 mouse. Connectors and media devices that are deactivated make resources available. You must restart the computer to effect the changes.

Manageability

Alert Standard Format

ASF is a DMTF management standard that specifies "pre-operating system" or "operating system-absent" alerting techniques. The standard is designed to generate an alert on potential security and fault conditions when the operating system is in a sleep state or the system is powered down. ASF is designed to supersede previous operating system-absent alerting technologies.

Your computer supports the following ASF alerts and remote capabilities:

Alert	Description
Chassis Intrusion/Chassis Intrusion Cleared	The computer chassis has been opened or the chassis intrusion alert has been cleared.
Corrupt BIOS	The system BIOS is corrupted.
Failure to Boot to BIOS	System BIOS did not complete loading upon initiation.
System Password Failure	System password invalid (after three failed attempts).
Entity Presence	Periodic heartbeats transmitted to verify system presence.
CPU Failure	Microprocessor is present but not functioning.

For more information about Dell's ASF implementation, see the *ASF User's Guide* and the *ASF Administrator's Guide*, which are available on the Dell Support website at support.dell.com.

Dell OpenManage IT Assistant

IT Assistant configures, manages, and monitors computers and other devices on a corporate network. IT Assistant manages assets, configurations, events (alerts), and security for computers equipped with industry-standard management software. It supports instrumentation that conforms to SNMP, DMI, and CIM industry standards.

Dell OpenManage Client Instrumentation, which is based on DMI and CIM, is available for your computer. For information on IT Assistant, see the *Dell OpenManage IT Assistant User's Guide* available on the Dell Support website at support.dell.com.

Dell OpenManage Client Instrumentation

Dell OpenManage Client Instrumentation is software that enables remote management programs such as IT Assistant to do the following:

- 1 Access information about your computer, such as how many processors it has and what operating system it is running
- 1 Monitor the status of your computer, such as listening for thermal alerts from temperature probes or hard-drive failure alerts from storage devices
- 1 Change the state of your computer, such as updating its BIOS or shutting it down remotely

A managed system is one that has Dell OpenManage Client Instrumentation set up on a network that uses IT Assistant. For information about Dell OpenManage Client Instrumentation, see the *Dell OpenManage Client Instrumentation User's Guide* available on the Dell Support website at support.dell.com.

Security

Chassis Intrusion Detection

 **NOTE:** When the setup password is enabled, you must know the setup password before you can reset the **Chassis Intrusion** setting.

This feature detects that the chassis was opened and alerts the user. To change the **Chassis Intrusion** setting:

1. [Enter system setup](#).
2. Press the down-arrow keys to move to the **System Security** option.
3. Press <Enter> to access the **System Security** option's popup menu.
4. Press the down-arrow key to move to the **Chassis Intrusion** setting.
5. Press the spacebar to select an option setting.
6. Exit system setup.

Option Settings

1. **Enabled** — If the computer cover is removed, the setting changes to **Detected**, and the following alert message displays during the boot routine at the next computer start-up:

```
Alert! Cover was previously removed.
```

To reset the **Detected** setting, [enter system setup](#). In the **Chassis Intrusion** option, press the left- or right-arrow key to select **Reset**, and then choose **Enabled**, **Enabled-Silent**, or **Disabled**.

1. **Enabled-Silent** (default) — If the computer cover is removed, the setting changes to **Detected**. No alert message appears during the boot sequence at the next computer start-up.
1. **Disabled** — No intrusion monitoring occurs and no messages appear.

Security Cable Slot

Attach a commercially available antitheft device to the security cable slot on the back of the cable cover (see "[Cable Cover](#)").

 **NOTE:** Before you purchase an antitheft device, make sure that it works with the security cable slot on your computer.

Antitheft devices usually include a segment of metal-stranded cable with an attached locking device and key. Dell recommends that you use a Kensington lock. The documentation that comes with the device contains instructions for installing it.

Password Protection

 **NOTICE:** Although passwords provide security for the data on your computer, they are not foolproof. If your data requires more security, it is your responsibility to obtain and use additional forms of protection, such as data encryption programs.

System Password

 **NOTICE:** If you leave your computer running and unattended without having a system password assigned, or if you leave your computer unlocked so that someone can disable the password by changing a jumper setting, anyone can access the data stored on your hard drive.

Option Settings

You cannot change or enter a new system password if either of the following two options is displayed:

1. **Enabled** — A system password is assigned.
1. **Disabled** — The system password is disabled by a jumper setting on the system board.

You can only assign a system password when the following option is displayed:

1. **Not Enabled** — No system password is assigned and the password jumper on the system board is in the enabled position (the default).

Assigning a System Password

To escape from the field without assigning a system password, press <Tab> or the <Shift><Tab> key combination to move to another field, or press <Esc> at any time before you complete step 5.

1. [Enter system setup](#) and verify that **Password Status** is set to **Unlocked**.
2. Highlight **System Password**, and then press the left- or right-arrow key.

The option heading changes to **Enter Password**, followed by an empty 32-character field in square brackets.

3. Type your new system password.

You can use up to 32 characters. To erase a character when entering your password, press <Backspace> or the left-arrow key. The password is not case sensitive.

Certain key combinations are not valid. If you enter one of these combinations, the speaker emits a beep.

As you press each character key (or the spacebar for a blank space), a placeholder appears in the field.

4. Press <Enter>.

If the new system password is less than 32 characters, the whole field fills with placeholders. Then the option heading changes to **Verify Password**, followed by another empty 32-character field in square brackets.

5. To confirm your password, type it a second time and press <Enter>.

The password setting changes to **Enabled**.

6. Exit system setup.

Password protection takes effect when you restart the computer.

Typing Your System Password

When you start or restart your computer, one of the following prompts appears on the screen.

If **Password Status** is set to **Unlocked**:

```
Type in the password and
- press <ENTER> to leave password security enabled.
- press <CTRL><ENTER> to disable password security.
Enter password:
```

If **Password Status** is set to **Locked**:

```
Type the password and press <Enter>.
```

If you have assigned a setup password, the computer accepts your setup password as an alternate system password.

If you type a wrong or incomplete system password, the following message appears on the screen:

```
** Incorrect password. **
```

If you again type an incorrect or incomplete system password, the same message appears on the screen. The third and subsequent times you type an incorrect or incomplete system password, the computer displays the following message:

```
** Incorrect password. **
Number of unsuccessful password attempts: 3
System halted! Must power down.
```

Even after your computer is turned off and on, the previous message is displayed each time you type an incorrect or incomplete system password.



NOTE: You can use **Password Status** in conjunction with **System Password** and **Setup Password** to further protect your computer from unauthorized changes.

Deleting or Changing an Existing System Password

1. [Enter system setup](#) and verify that **Password Status** is set to **Unlocked**.
2. Restart your computer.
3. When prompted, type the system password.
4. Press <Ctrl><Enter> to disable the existing system password.
5. Confirm that **Not Enabled** is displayed for the **System Password** option.

If **Not Enabled** is displayed, the system password is deleted. If **Not Enabled** is not displayed, press <Alt> to restart the computer, and then repeat [step 3](#) through [step 5](#).

To assign a new password, follow the procedure in "[Assigning a System Password](#)."

6. Exit system setup.

Setup Password

Option Settings

- 1 **Enabled** — Does not allow assignment of setup passwords; users must enter a setup password to make changes to system setup
- 1 **Not Enabled** — Allows assignment of setup passwords; password feature is enabled but no password is assigned

Assigning a Setup Password

The setup password can be the same as the system password.

 **NOTE:** If the two passwords are different, the setup password can be used as an alternate system password. However, the system password cannot be used in place of the setup password.

1. [Enter system setup](#) and verify that **Setup Password** is set to **Not Enabled**.
2. Highlight **Setup Password** and press the left- or right-arrow key.

The computer prompts you to type and verify the password. If a character is not permitted, the computer emits a beep.

3. Type and then verify the password.

After you verify the password, the **Setup Password** setting changes to **Enabled**. The next time you [enter system setup](#), the computer prompts you for the setup password.

4. Exit system setup.

A change to **Setup Password** becomes effective immediately (no need to restart the computer).

Operating Your Computer With a Setup Password Enabled

When you [enter system setup](#), the **Setup Password** option is highlighted, prompting you to type the password.

If you do not type the correct password, the computer allows you to view, but not modify, system setup options.

 **NOTE:** You can use **Password Status** in conjunction with **Setup Password** to protect the system password from unauthorized changes.

Deleting or Changing an Existing Setup Password

To change an existing setup password, you must know the setup password.

1. [Enter system setup](#).
2. Type the setup password at the prompt.
3. Highlight **Setup Password** and press the left- or right-arrow key to delete the existing setup password.

The setting changes to **Not Enabled**.

To assign a new setup password, perform the steps in "[Assigning a System Password](#)."

4. Exit system setup.

Disabling a Forgotten Password and Setting a New Password

 **NOTICE:** This process erases both the system and setup passwords.

 **CAUTION:** Before you begin any of the procedures in this section, follow the steps in "[CAUTION: Safety Instructions](#)."

1. [Remove the computer cover](#).

 **NOTICE:** Before touching anything inside your computer, ground yourself by touching an unpainted metal surface, such as the metal at the back of the computer. While you work, periodically touch an unpainted metal surface to dissipate any static electricity that could harm internal components.

2. Remove the jumper plug labeled "PSWD" from the jumper.
See "[Jumper Settings](#)" to locate the password jumper.
3. Replace the computer cover.
4. Reconnect your computer and devices to electrical outlets and turn them on.

This disables the existing password(s).

5. [Enter system setup](#) and verify that **Setup Password** is set to **Disabled**.
6. Exit system setup.

 **CAUTION:** Before you begin any of the procedures in this section, follow the steps in "[CAUTION: Safety Instructions](#)."

7. Remove the computer cover.

 **NOTICE:** Before touching anything inside your computer, ground yourself by touching an unpainted metal surface, such as the metal at the back of the computer. While you work, periodically touch an unpainted metal surface to dissipate any static electricity that could harm internal components.

8. Replace the PSWD jumper plug.
9. Replace the computer cover and reconnect the computer and devices to electrical outlets and turn them on.

This reenables the password feature. When you [enter system setup](#), both password options appear as **Not Enabled**—the password feature is enabled but no password is assigned.

10. Assign a new system and/or setup password.

System Setup

Use system setup settings as follows:

- 1 To set user-selectable options such as date and time or system password
- 1 To read the current amount of memory or set the type of hard drive installed

Print the system setup screens (by pressing <Print Screen>) or record the information for future reference.

Before you use system setup, you must know the kind of floppy drive(s) and hard drive(s) installed in your computer. To confirm this information, see the Manufacturing Test Report that came with your computer, or find this information in the online **Dell Accessories** folder.

Entering System Setup

1. Turn on or restart your computer.
2. When **Press <F2> to Enter Setup** appears in the upper-right corner of the screen, press <F2> immediately.

If you wait too long and the Microsoft® Windows® logo appears, continue to wait until you see the Windows desktop. Then shut down your computer through the **Start** menu and try again.

 **NOTE:** To ensure an orderly computer shutdown, see the documentation that came with your operating system.

System Setup Screens



System setup screens display current configuration information for your computer. Information on the screen is organized into four areas:



















- 1 Title — The box at the top of all screens that lists the computer name.
- 1 Computer data — Two boxes below the title box that display your computer processor, L2 cache, service tag, and the version number of the BIOS.
- 1 Options — A scrollable box listing options that define the configuration of your computer, including installed hardware, power conservation, and security features.

Fields to the right of the option titles contain settings or values. The fields that you can change appear bright on the screen. The fields that you cannot change (because they are set by the computer) appear less bright. When <Enter> appears to the right of an option title, press <Enter> to access a popup menu of additional options.

- 1 Key functions — A line of boxes across the bottom of all screens that lists keys and their functions within system setup.

System Setup Navigation Keys

Keys	Action
 or 	Moves to the next field.
	Moves to the previous field.

  or 	
 or 	Cycles through the options in a field. In many fields, you can also type the appropriate value.
 or 	Scrolls through help information.
	Enters the selected field's popup options menu.
spacebar or  or 	In the selected field's popup options menu, cycles through the options in a field.
 	Exits system setup without restarting the computer and returns the computer to the boot routine.
 	Exits system setup and restarts the computer, implementing any changes you have made.
 	Resets the selected option to the default.
 	Restores all system settings to the default configuration.

Boot Sequence

This feature allows users to change the sequence of devices from which the computer boots.

Option Settings

- 1 **Normal** — (Available only for the current boot process) The computer attempts to boot from the sequence of devices specified in system setup.
- 1 **Diskette Drive** — The computer attempts to boot from the floppy drive. If the floppy disk in the drive is not bootable, or if no floppy disk is in the drive, the computer generates an error message.
- 1 **Hard Drive** — The computer attempts to boot from the primary hard drive. If no operating system is on the drive, the computer generates an error message.
- 1 **CD Drive** — The computer attempts to boot from the CD drive. If no CD is in the drive, or if the CD has no operating system, the computer generates an error message.
- 1 **PXE** — (Available only for the future boot process) As the computer boots, it prompts the user to press <Ctrl><Alt>. Pressing this key combination causes a menu to display that allows you to select a method for booting from a network server. If a boot routine is not available from the network server, the system attempts to boot from the next device in the boot sequence list.
- 1 **USB Flash Device** — Insert the memory device into a USB port and restart the computer. When F12 = Boot Menu appears in the upper-right corner of the screen, press <F12>. The BIOS detects the device and adds the USB flash option to the boot menu.

 **NOTE:** To boot to a USB Flash device, the device must be bootable. To make sure your device is bootable, check the device documentation or website.

Changing Boot Sequence for the Current Boot

You can use this feature, for example, to tell the computer to boot from the CD drive so you can run the Dell Diagnostics, but specify that the computer boots from the hard drive when the diagnostic tests are complete.

If you wait too long and the Windows logo appears, continue to wait until you see the Windows desktop. Then shut down your computer through the **Start** menu and try again.

1. Turn on or restart your computer.
2. When <F12> = Boot Menu appears in the upper-right corner of the screen, press <F12> to access the boot menu.

If you wait too long and the Windows logo appears, continue to wait until you see the Windows desktop. Then shut down your computer through the **Start** menu and try again.

 **NOTE:** To ensure an orderly computer shutdown, consult the documentation that came with your operating system.

The **Boot Device Menu** appears, listing all available boot devices. Each device has a number next to it. At the bottom of the menu, enter the number of the device that is to be used for the current boot only.

Changing Boot Sequence for Future Boots

1. [Enter system setup.](#)
2. Use the arrow keys to highlight the **Boot Sequence** menu option and press <Enter> to access the pop up menu.

 **NOTE:** Write down your current boot sequence in case you want to restore it.

3. Press the up- and down-arrow keys to move through the list of devices.
4. Press the spacebar to enable or disable a device (enabled devices have a checkmark).
5. Press plus (+) or minus (-) to move a selected device up or down the list.

System Setup Options

Drive Configuration

- 1 **Diskette Drive A** — The type of floppy drive installed in the module bay. The two options are **3.5 Inch, 1.44 MB** (default) and **Not Installed**. This field is automatically updated if a floppy drive is detected during startup and the diskette interface is set to **Auto**.
- 1 **Primary Drive and Secondary Drive** — The settings are **Auto** (use this setting for all IDE devices from Dell) and **Off**.

Primary Drive identifies drives attached to the primary IDE interface connector (labeled "IDE1") on the system board.

Secondary Drive identifies drives installed in the module bay.

NOTE: You must have an IDE device connected to the primary IDE interface if you have an IDE device connected to the secondary IDE interface.

- 1 **IDE Drive UDMA** — The settings are **UDMA On** (default) or **Off**.

This field enables/disables DMA transfers for the internal IDE hard-disk interface (UDMA). This feature can be used to improve data throughput when booting or resuming the operating system.

If You Have a Problem —

See "[Hard drive problems.](#)"

Tape drives are not reflected in the **Drive Configuration** option.

Boot Sequence — See "[Boot Sequence.](#)"

Memory Information — Indicates amount of installed memory, computer memory speed, video memory, size of the display cache, and channel mode (dual or single).

CPU Information

- 1 **CPU Speed** — The processor speed at which the computer boots.

Press the left- or right-arrow key to toggle the **CPU Speed** option between the resident microprocessor's rated speed (the default) and a lower-compatibility speed. A change to this option takes effect immediately (no restart is necessary).

To toggle between the rated processor speed and the compatibility speed while the computer is running in real mode, press <Ctrl><Alt><\>. (For keyboards that do not use American English, press <Ctrl><Alt><#>.)

- 1 **Bus Speed** — The speed of the microprocessor's system bus.
- 1 **Processor ID** — The manufacturer's identification code(s) for the installed microprocessor.
- 1 **Clock Speed** — The core speed at which the microprocessor(s) operates.
- 1 **Cache Size** — The size of the microprocessor's L2 cache.
- 1 **Hyper-Threading** — Enables or disables Hyper-Threading technology for systems that support Hyper-Threading. The default setting is **Disabled**.

Integrated Devices (LegacySelect Options) — Configures the following devices integrated with the system board:

- 1 **Sound** — The settings are **On** (default) or **Off**.
- 1 **Network Interface Controller** — The settings are **On** (default), **Off**, or **On w/ PXE**. See "[Boot Sequence](#)" for more information.
- 1 **Mouse Port** — The settings are **On** (default) or **Off**.
- 1 **USB Emulation** — The settings are **On** (default), **Off**, and **No Boot**.

USB emulation allows USB devices to work with operating systems that do not have direct USB support.

NOTE: This is effective when the USB Controller is set to **On**.

- 1 **On** — USB emulation continues when control is passed to the operating system.
- 1 **Off** — USB emulation ends when control is passed to the operating system.
- 1 **No BOOT** — USB emulation continues, but USB boot devices are disabled.

- 1 **USB Controller** — The settings are **On** (default) or **Off**.

NOTE: USB devices will not be detected and supported in the operating system if the USB Controller is set to **Off**.

- 1 **Serial Port 1** — The settings are **Auto** (default), **COM1**, **COM3** and **Off**.

Auto automatically configures a connector to a particular designation (**COM1** or **COM3** for **Serial Port 1**).

- 1 **Parallel Port** — The settings are **Mode**, **I/O Address**, and **DMA Channel**.

- 1 **Mode** settings are **PS/2** (default), **EPP**, **ECP**, **AT**, or **Off**. Set the **Mode** option according to the type of device connected to the parallel connector. To determine the correct mode to use, see the documentation that came with the device.
- 1 **I/O Address** settings are **378h** (default), **278h**, or **3BCh**. The settings are not available when **Mode** is set to **Off**.

NOTE: You cannot set the parallel connector to **3BCh** if **Mode** is set to **EPP**.

- 1 **DMA Channel** appears only when **Mode** is set to **ECP**. The settings are **DMA 1**, **DMA 3**, or **Off**.

- 1 **Module Bay** — The settings are **On** (default), **Off**, **FDD only**, and **IDE only**.
 - 1 **On** — Floppy Disk Drive (FDD) and IDE compatible devices function in bay.
 - 1 **Off** — No devices function in bay (used for security).
 - 1 **FDD only** — Floppy Disk Drive only functions in bay.
 - 1 **IDE only** — IDE compatible devices only function in bay.

- 1 **Diskette Interface** — The settings are **Auto** (default), **Read Only**, and **Off**.
 - 1 **Auto** turns on the floppy drive controller.
 - 1 **Read Only** prevents the computer's integrated floppy drive controller from writing to floppy drives and activates **Auto**.
 - 1 **Off** turns off the floppy drive controller.
- 1 **PC Speaker** — The settings are **On** (default) and **Off**.
- 1 **Onboard Video Buffer** — Determines how much system memory is allocated to video. The settings are **1 MB** (default) and **8 MB**.

Power Management —

See "[Power Management](#)" for additional information.

- 1 **Suspend Mode** — The settings are **S3** (default) or **S1**.
 - 1 **S3** — Maximum power savings
 - 1 **S1** — Minimal power savings

AC Power Recovery — Determines what happens when AC power is restored to the computer.

- 1 **Off** (default) — The computer remains off when AC power is restored.
- 1 **On** — The computer starts when AC power is restored.
- 1 **Last** — The computer returns to the AC power state existing at the time that AC power was lost.
- 1 **Low Power Mode** — The options are **Disabled** or **Enabled**.

NOTE: When **Low Power Mode** is **Enabled**, remote wakeup events will no longer power up from **Hibernate** or **Off**.

System Security — See "[Security](#)."

Keyboard NumLock — The settings are **On** (default) and **Off** (does not apply to 84-key keyboards).

- 1 **On** activates the rightmost bank of keys so they provide the mathematical and numeric functions shown at the top of each key.
- 1 **Off** activates the rightmost bank of keys so they provide cursor-control functions shown by the label on the bottom of each key.

Report Keyboard Errors — The settings are **Report** (default) and **Do Not Report**.

Auto Power On — Sets time and days of week to turn on the computer automatically. Choices are every day or every Monday through Friday.

Time is kept in a 24-hour format (*hours:minutes*). Change the startup time by pressing the right- or left-arrow keys to increase or decrease the numbers or type numbers in both the date and time fields.

Disabled is the default.

This feature does not work if you turn off your computer using a power strip or surge protector.

Remote Wakeup — The settings are **Off** (default), **On**, and **On w/ Boot to NIC**.

- 1 **On** allows the system to power up when a Network Interface Controller or Remote Wake Up capable modem receives a wake up signal.
- 1 **Off** disables the remote wakeup functionality.
- 1 **On w/ Boot to NIC** causes the system to attempt a network boot prior to using the boot sequence.

Normally the system can be powered up remotely from suspend mode, hibernate mode, or when powered off. When **Low Power Mode** (in the **Power Management** menu) is enabled, the system can only be powered up remotely from **Suspend**.

Fastboot

- 1 **On** (default) — Your computer boots in 10 seconds or less, skipping certain configurations and tests.
- 1 **Off** — Your computer does not skip certain configurations and tests during the boot process.

IDE Hard Drive Acoustics Mode

The acoustics mode field may contain the following options:

- 1 **Quiet** — The hard drive operates in its quietest setting.
- 1 **Performance** — The hard drive operates at its maximum speed.

NOTE: Switching to **Performance** mode may cause the drive to be noisier, but its performance is not affected.

- 1 **Bypass** (default) — Your computer does not test or change the current acoustics mode setting.
- 1 **Suggested** — The hard drive operates at the level suggested by the hard drive manufacturer.

NOTE: Changing the acoustics setting does not alter your hard drive image.

Asset Tag — Displays the customer-programmable asset tag number for the computer if an asset tag number is assigned.

Booting to a USB Device

 **NOTE:** To boot to a USB device, the device must be bootable. To ensure that your device is bootable, check the device documentation.

Memory Key

1. Insert the memory key into a USB port and restart the computer.
2. When **F12 = Boot Menu** appears in the upper-right corner of the screen, press **<F12>**.

The BIOS detects the device and adds the USB flash option to the boot menu.

3. From the boot menu, select the number that appears next to the USB device.

The computer boots to the USB device.

Floppy Drive

1. Disable the integrated floppy controller by entering system setup, going to integrated devices, and setting the diskette interface to **Off**.
2. In system setup, go to **Drive Configuration** and make sure the **Diskette Drive A** option is set to **3.5 Inch, 1.44 MB**.
3. Connect the USB floppy drive, insert a bootable diskette, and re-boot the system.

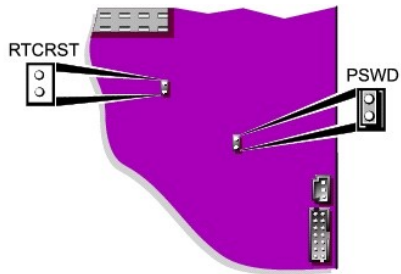

Jumper Settings



 **NOTICE:** Ensure that your computer is turned off and unplugged before you change the jumper settings. Otherwise, damage to your computer or unpredictable results can occur.

 **NOTICE:** Before touching anything inside your computer, ground yourself by touching an unpainted metal surface, such as the metal at the back of the computer. While you work, periodically touch an unpainted metal surface to dissipate any static electricity that could harm internal components.

To change a jumper setting, pull the plug off its pin(s) and carefully fit it down onto the pin(s) indicated.

Jumper	Setting	Description
PSWD	 (default)	Password features are enabled.
		Password features are disabled.

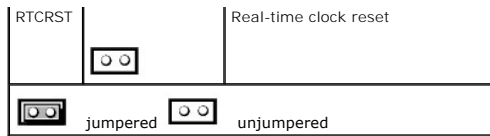

Power Button

NOTICE: To turn off your computer, perform an orderly computer shutdown when possible.

You can use the ACPI feature to configure the function of the Microsoft Windows 2000, and Windows XP operating systems.

Power Button Functions With ACPI Enabled

Action	Results		
	Computer Turned On and ACPI Enabled	Computer in Standby Mode	Computer Turned Off
Press power button	Computer goes into standby mode or turns off (depending on the operating system setup)	Computer turns on	Boots and computer turns on
Hold power button for 6 seconds*	Computer turns off	Computer turns off	Boots and computer turns on

NOTE: Pressing or holding the power button to shut down the computer may result in data loss. Use the power button to shut down the computer only if the operating system is not responding.

Power Button Functions With ACPI Disabled

Action	Results		
	Computer Turned On and ACPI Disabled	Computer in Suspend Mode	Computer Turned Off
Press power button	Computer turns off immediately	Computer turns off immediately	Boots and computer turns on
Hold power button for 6 seconds*	Computer turns off	Computer turns off	Boots and computer turns on

NOTE: Pressing or holding the power button to shut down the computer may result in data loss. Use the power button to shut down the computer only if the operating system is not responding.

Power Button Functions for Windows NT

Action	Results	
	Computer Turned On	Computer Turned Off
Press power button	Computer shuts down	Boots and computer turns on
Hold power button for 6 seconds*	Computer turns off	Boots and computer turns on

NOTE: Pressing or holding the power button to shut down the computer may result in data loss. Use the power button to shut down the computer only if the operating system is not responding.

Power Management

Your computer can be set to use less power when you are not working. You control the power usage through the operating system installed on your computer and certain option settings in [system setup](#). These periods of reduced power are called "sleep states:"

- 1 **Standby**—In this sleep state, power is reduced or turned off for most components, including the cooling fans. However, system memory remains active.

This state is not supported by Windows NT 4.0.

 **NOTE:** All components installed in the computer must support this feature and have the appropriate drivers loaded to enter standby. For more information, see the manufacturer's documentation for each component.

- 1 **Hibernate**—This sleep state reduces power consumption to a minimum by writing all data in system memory to a hard drive and then removing system power. Waking up from this state restarts the computer, and the memory contents are restored. Operation then resumes where the computer left off when it entered the hibernation state.

This state is not supported by Windows NT 4.0.

 **NOTE:** All components installed in the computer must support this feature and have the appropriate drivers loaded to enter hibernation. For more information, see the manufacturer's documentation for each component.

- 1 **Shutdown**—This sleep state removes all power from the computer except a small auxiliary amount. As long as the computer remains connected to an electrical outlet, it can be automatically or remotely started. For example, the **Auto Power On** option in [system setup](#) allows the computer to automatically start at a specified time. Also, your network administrator can remotely start your computer using a power management event such as Remote Wake Up.

The following table lists the sleep states and the methods you can use to wake the computer from each state.

Sleep State	Wake-Up Methods (Windows 2000 and XP)
Standby	<ul style="list-style-type: none"> 1 Press the power button 1 Auto power on 1 Move or click the mouse 1 Type on the keyboard 1 USB device activity 1 Power management event
Hibernate	<ul style="list-style-type: none"> 1 Press the power button 1 Auto power on 1 Power management event
Shutdown	<ul style="list-style-type: none"> 1 Press the power button 1 Auto power on 1 Power management event

 **NOTE:** For more information on power management, see your operating system documentation.

Hyper-Threading

Hyper-Threading is an Intel® technology that can enhance overall computer performance by allowing one physical microprocessor to function as two logical microprocessors, capable of performing certain tasks simultaneously. It is recommended that you use the Microsoft® Windows® XP SP1 or later operating system because Windows XP is optimized to take advantage of Hyper-Threading technology. While many programs can benefit from Hyper-Threading, some programs have not been optimized for Hyper-Threading and may require an update from the software manufacturer. Contact the software manufacturer for updates and information about using Hyper-Threading with your software.

To determine if your computer is using Hyper-Threading technology:

1. Click the **Start** button, right-click **My Computer**, and then click **Properties**.
2. Click **Hardware** and click **Device Manager**.
3. In the **Device Manager** window, click the plus (+) sign next to the processor type. If Hyper-Threading is enabled, the processor is listed twice.

You can enable or disable Hyper-Threading through [system setup](#).

[Back to Contents Page](#)

Battery

Dell™ OptiPlex™ SX270 Systems User's Guide

⚠ CAUTION: Before you begin this procedure, follow the steps in "[CAUTION: Safety Instructions](#)."

⚠ CAUTION: To prevent static damage to components inside your computer, discharge static electricity from your body before you touch any of your computer's electronic components. You can do so by touching an unpainted metal surface on the computer chassis.

A coin-cell battery maintains computer configuration, date, and time information. The battery can last several years.

The battery may need replacing if an incorrect time or date is displayed during the boot routine along with a message such as:

```
Time-of-day not set - please run SETUP program
```

or

```
Invalid configuration information -  
please run SETUP program
```

or

```
Strike the F1 key to continue,  
F2 to run the setup utility
```

To determine whether you need to replace the battery, reenter the time and date in system setup and exit the program to save the information. Turn off your computer and disconnect it from the electrical outlet for a few hours, then reconnect the computer, turn it on, and enter system setup. If the date and time are not correct in system setup, replace the battery.

You can operate your computer without a battery; however, without a battery, the configuration information is erased if the computer is turned off or unplugged from the electrical outlet. In this case, you must enter system setup and reset the configuration options.

⚠ CAUTION: A new battery can explode if it is incorrectly installed. Replace the battery only with the same or equivalent type recommended by the manufacturer. Discard used batteries according to the manufacturer's instructions.

1. If you have not already done so, make a copy of your configuration information, found in system setup (see "[System Setup](#)").
2. Remove the cable cover (if used).
3. Remove the stand (if used).
4. Remove the computer cover.
5. Locate the battery socket labeled BATTERY (see "[System Board Components](#)").
6. To remove the battery, grip the battery and slightly twist it as you lift it out of the connector.
7. Insert the new battery into the socket with the side labeled with the symbol (+) *not* facing the opening, and snap the battery down into place.

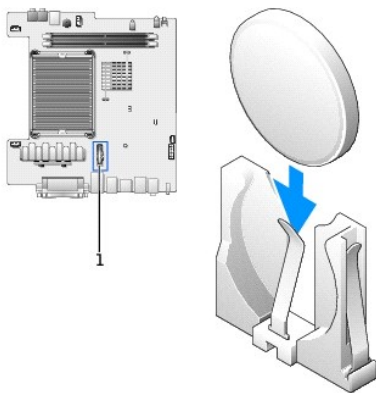

1	location of the battery connector
---	-----------------------------------

8. Replace the computer cover.
9. Reattach the stand (if used).

10. Replace the cable cover (if used).

 **NOTICE:** To connect a network cable, first plug the cable into the network wall jack and then plug it into the computer.

11. Connect your computer to the adapter cable and devices to electrical outlets, and turn them on.

After you replace the cover, the chassis intrusion detector, if enabled, causes the following message to appear on the screen at the next computer start-up:

ALERT! Cover was previously removed.

12. [Reset the chassis intrusion detector](#) by changing the **Chassis Intrusion** option to **Enabled** or **Enabled-Silent**.

 **NOTE:** If a setup password has been assigned by someone else, contact your network administrator for information on resetting the chassis intrusion detector.

13. [Enter system setup](#) and restore the settings you recorded in step 1.

14. [Properly dispose of the old battery](#).

[Back to Contents Page](#)

[Back to Contents Page](#)

Cleaning Your Computer

Dell™ OptiPlex™ SX270 Systems User's Guide

- [Computer, Keyboard, and Monitor](#)
- [Mouse](#)
- [Floppy Drive](#)
- [CDs and DVDs](#)

 **CAUTION:** Before you begin any of the procedures in this section, read the safety instructions in "[CAUTION: Safety Instructions.](#)"

Computer, Keyboard, and Monitor

 **CAUTION:** Before you clean your computer, disconnect the computer from the electrical outlet. Clean your computer with a soft cloth dampened with water. Do not use liquid or aerosol cleaners, which may contain flammable substances.

1. Use a vacuum cleaner with a brush attachment to gently remove dust from the slots and holes on your computer and from between the keys on the keyboard.

 **NOTICE:** Do not wipe the display screen with any soap or alcohol solution. Doing so may damage the antiglare coating.

1. To clean your monitor screen, lightly dampen a soft, clean cloth with water. If possible, use a special screen-cleaning tissue or solution suitable for the monitor's antistatic coating.
1. Wipe the keyboard, computer, and plastic part of the monitor with a soft cleaning cloth moistened with a solution of three parts water and one part dishwashing detergent.

Do not soak the cloth or allow water to drip inside your computer or keyboard.

Mouse

If your screen cursor skips or moves abnormally, clean the mouse. To clean a non-optical mouse:

1. Turn the retainer ring on the underside of your mouse counterclockwise, and then remove the ball.
 2. Wipe the ball with a clean, lint-free cloth.
 3. Blow carefully into the ball cage to dislodge dust and lint.
 4. If the rollers inside the ball cage are dirty, clean the rollers with a cotton swab moistened lightly with isopropyl alcohol.
 5. Recenter the rollers in their channels if they are misaligned. Ensure that fluff from the swab is not left on the rollers.
 6. Replace the ball and retainer ring, and turn the retainer ring clockwise until it clicks into place.
-

Floppy Drive

 **NOTICE:** Do not attempt to clean drive heads with a swab. You might accidentally misalign the heads, which prevents the drive from operating.

Clean your floppy drive using a commercially available cleaning kit. These kits contain pretreated floppy disks to remove contaminants that accumulate during normal operation.

CDs and DVDs

 **NOTICE:** Always use compressed air to clean the lens in the CD/DVD drive, and follow the instructions that come with the compressed air. Never touch the lens in the drive.

If you notice problems, such as skipping, with the playback quality of your CDs or DVDs, try cleaning the discs.

1. Hold the disc by its outer edge. You can also touch the inside edge of the center hole.

 **NOTICE:** To prevent damaging the surface, do not wipe in a circular motion around the disc.

2. With a soft, lint-free cloth, gently wipe the bottom of the disc (the unlabeled side) in a straight line from the center to the outer edge of the disc.

For stubborn dirt, try using water or a diluted solution of water and mild soap. You can also purchase commercial products that clean discs and provide some protection from dust, fingerprints, and scratches. Cleaning products for CDs are safe to use on DVDs.

[Back to Contents Page](#)

Module Bay

Dell™ OptiPlex™ SX270 Systems User's Guide

- [Installing a Device When Your Computer Is Turned Off](#)
- [Installing a Device When Your Computer Is Running Microsoft Windows® XP](#)
- [Installing a Device When Your Computer Is Running Windows 2000](#)

You can install a Dell™ portable device such as a floppy drive, CD/DVD drive or second hard drive in the module bay.

Your Dell computer ships with either a floppy drive or an airbay (filler blank) installed in the module bay.

- ➡ **NOTICE:** To prevent damage to devices, place them in a safe, dry place when they are not installed in the computer. Avoid pressing down on them or placing heavy objects on top of them.

Installing a Device When Your Computer Is Turned Off

To install a CD/DVD device or second hard drive:

1. If the module bay is locked, [open the hard-drive door](#) and move the module locking switch to the unlocked position.

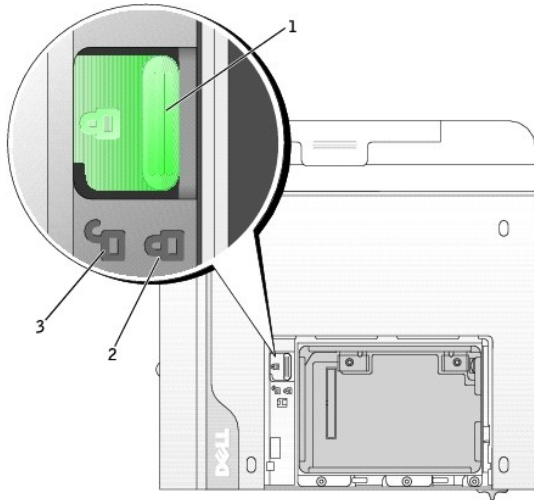

1	module locking switch
2	locked position
3	unlocked position

2. While pressing the module eject button, grasp the airbay and pull it out of the module bay.

- ➡ **NOTICE:** Do not place any heavy objects on top of the computer. Doing so may cause difficulty in removing a module device.

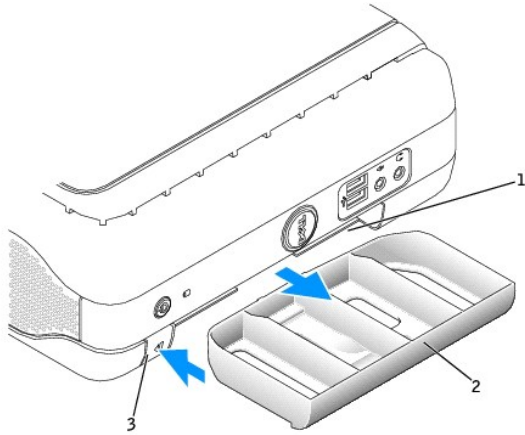

1	module bay
2	airbay
3	module eject button

3. Slide the device into the module bay.
4. If desired, you may lock the device in the module bay by moving the module locking switch to the locked position.
5. Replace the hard-drive door.

To remove a floppy drive, follow steps 1 and 2.

Installing a Device When Your Computer Is Running Microsoft Windows® XP

To install a CD/DVD device or second hard drive:

1. Double-click the **Safely Remove Hardware** icon on the taskbar.
2. Click the device you want to eject.
3. If the module bay is locked, [open the hard-drive door](#) and move the [module locking switch](#) to the unlocked position.
4. While pressing the module eject button, grasp the [airbay](#) and pull it out of the module bay.

➡ **NOTICE:** Do not place any heavy objects on top of the computer. Doing so may cause difficulty in removing a module device.

5. Slide the device into the [module bay](#).
6. If desired, you may lock the device in the module bay by moving the module locking switch to the locked position.
7. Replace the hard-drive door.

Windows XP automatically recognizes the new device.

8. If necessary, enter your password to unlock your computer.

Installing a Device When Your Computer Is Running Windows 2000

To install a CD/DVD device or second hard drive:

1. Click the **Unplug or Eject Hardware** icon on the taskbar.
2. Click the device you want to eject and click **Stop**.
3. If the module bay is locked, [open the hard-drive door](#) and move the [module locking switch](#) to the unlocked position.
4. While pressing the module eject button, grasp the [airbay](#) and pull it out of the module bay.

➡ **NOTICE:** Do not place any heavy objects on top of the computer. Doing so may cause difficulty in removing a module device.

5. Slide the device into the [module bay](#).

6. If desired, you may lock the device in the module bay by moving the module locking switch to the locked position.
 7. Replace the hard-drive door.
 8. When the operating system recognizes the new device, click **Close**.
-

[Back to Contents Page](#)

Replacing the Computer Cover

Dell™ OptiPlex™ SX270 Systems User's Guide

1. Ensure that no tools or extra parts are left inside the computer.
2. Replace the cover:
 - a. Lower and align the cover with the two lines on the metal computer frame.
 - a. Slide the cover until you hear or feel it click into place.

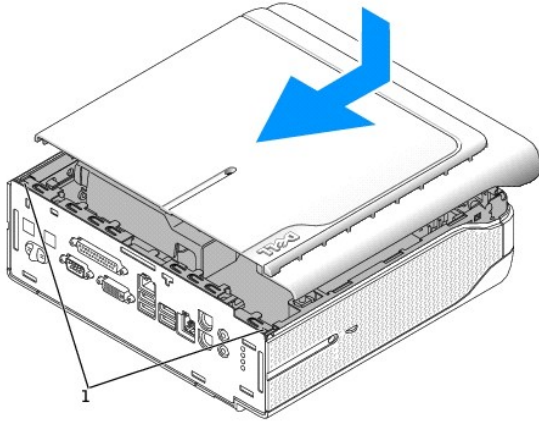

1 alignment lines

NOTE: To connect a network cable, first plug the cable into the network wall jack, and then plug it into the computer.

3. Connect your computer to its power adapter and connect devices to electrical outlets, and turn them on.

After you replace the cover, the chassis intrusion detector, if enabled, causes the following message to appear on the screen at the next computer start-up:

ALERT! Cover was previously removed.

4. [Reset the chassis intrusion detector](#) by changing **Chassis Intrusion** to **Enabled** or **Enabled-Silent**.

NOTE: If a setup password has been assigned by someone else, contact your network administrator for information on resetting the chassis intrusion detector.

Removing the Computer Cover

Dell™ OptiPlex™ SX270 Systems User's Guide

⚠ CAUTION: Before you begin this procedure, follow the steps in "[CAUTION: Safety Instructions.](#)"

⚠ CAUTION: To prevent static damage to components inside your computer, discharge static electricity from your body before you touch any of your computer's electronic components. You can do so by touching an unpainted metal surface on the computer chassis.

1. Shut down the computer through the **Start** menu.
2. Ensure that your computer and attached devices are turned off. If your computer and attached devices did not automatically turn off when you shut down your computer, turn them off now.

➡ NOTICE: To disconnect a network cable, first unplug the cable from your computer and then unplug it from the network wall jack.

3. Remove the cable cover, if it is attached.
4. Disconnect any telephone or telecommunication lines from the computer.
5. Disconnect your computer and all attached devices from their electrical outlets, and then press the power button to ground the system board.
6. If your computer has the stand in the horizontal position, remove the stand.

⚠ CAUTION: To guard against electrical shock, always unplug your computer from the electrical outlet before removing the cover.

7. Remove the computer cover.

➡ NOTICE: Before touching anything inside your computer, ground yourself by touching an unpainted metal surface. While you work, periodically touch an unpainted metal surface to dissipate any static electricity that could harm internal components.

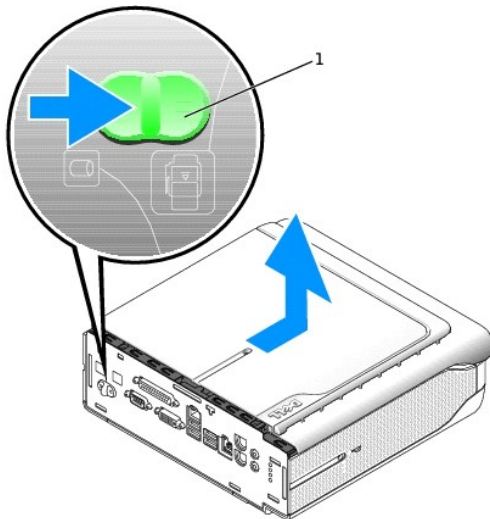

- a. Press the cover release button as shown in the illustration.
- b. Slide the computer cover forward 1/2 inch (1 cm), or until it stops, and then raise the cover.



1 release button

Ergonomic Computing Habits

Dell™ OptiPlex™ SX270 Systems User's Guide

-  **CAUTION:** Improper or prolonged keyboard use may result in injury.
-  **CAUTION:** Viewing the monitor screen for extended periods of time may result in eye strain.

For comfort and efficiency, observe the following ergonomic guidelines when setting up and using your computer workstation:

- 1 Position your computer so that the monitor and keyboard are directly in front of you as you work. Special shelves are commercially available to help you correctly position your keyboard.
- 1 Set the monitor at a comfortable viewing distance (usually 450 to 610 millimeters [18 to 24 inches] from your eyes).
- 1 Make sure the monitor screen is at eye level or slightly lower when you are sitting in front of the monitor.
- 1 Adjust the tilt of the monitor, its contrast and brightness settings, and the lighting around you (such as overhead lights, desk lamps, and the curtains or blinds on nearby windows) to minimize reflections and glare on the monitor screen.
- 1 Use a chair that provides good lower back support.
- 1 Keep your forearms horizontal with your wrists in a neutral, comfortable position while using the keyboard or mouse.
- 1 Always leave space to rest your hands while using the keyboard or mouse.
- 1 Let your upper arms hang naturally at your sides.
- 1 Ensure that your feet are resting flat on the floor.
- 1 When sitting, make sure the weight of your legs is on your feet and not on the front of your chair seat. Adjust your chair's height or use a footrest, if necessary, to maintain proper posture.
- 1 Vary your work activities. Try to organize your work so that you do not have to type for extended periods of time. When you stop typing, try to do things that use both hands.

For more information about ergonomic computing habits, see the BSR/HFES 100 standard, which can be purchased on the Human Factors and Ergonomics Society (HFES) website at: www.hfes.org/publications/HFES100.html

Example:

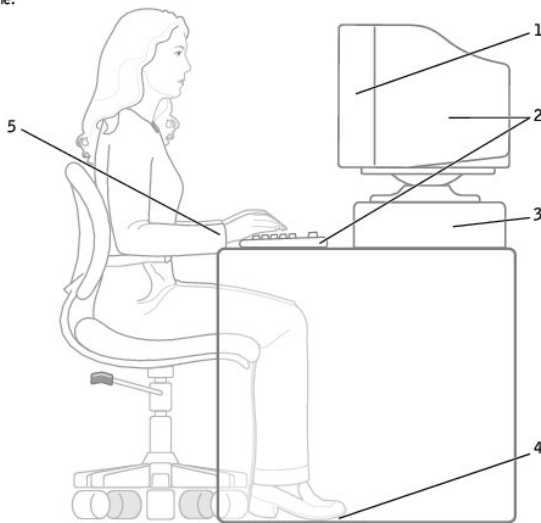

1	monitor screen at or below eye level	4	feet flat on the floor
2	monitor and keyboard positioned directly in front of the user	5	wrists relaxed and flat
3	monitor stand		

References:





1. American National Standards Institute. *ANSI/HFES 100: American National Standards for Human Factors Engineering of Visual Display Terminal Workstations*. Santa Monica, CA: Human Factors Society, Inc., 1988.
2. Human Factors and Ergonomics Society. *BSR/HFES 100 Draft standard for trial use: Human Factors Engineering of Computer Workstations*. Santa Monica, CA: Human Factors and Ergonomics Society, 2002.
3. International Organization for Standardization (ISO). *ISO 9241 Ergonomics requirements for office work with visual display terminals (VDTs)*. Geneva,

Switzerland: International Organization for Standardization, 1992.

[Back to Contents Page](#)

Finding Information for Your Computer

Dell™ OptiPlex™ SX270 Systems User's Guide

What are you looking for?	Find It Here
<ul style="list-style-type: none"> 1 A diagnostic program for my computer 1 Drivers for my computer 1 My computer documentation 1 My device documentation 	<p>Drivers and Utilities CD (also known as the ResourceCD)</p> <p>Documentation and drivers are already installed on your computer when shipped from Dell. You can use the CD to reinstall drivers, run the Dell Diagnostics, or access your documentation.</p>  <p>Readme files may be included on your CD to provide last-minute updates about technical changes to your computer or advanced technical-reference material for experienced users or technicians.</p>
<ul style="list-style-type: none"> 1 How to set up my computer 1 Troubleshooting information 1 Tools and utilities 1 Warranty information 	
<ul style="list-style-type: none"> 1 How to remove and replace parts 1 How to obtain technical specifications 1 How to configure system settings 1 How to troubleshoot and solve problems 	<p>User's Guide Windows Help and Support Center</p> <ol style="list-style-type: none"> 1. Click the Start button and click Help and Support. 2. Click User's and system guides and click User's guides. <p>Microsoft Windows 2000</p>  <p>Double-click the User's Guides icon on your desktop.</p>
<ul style="list-style-type: none"> 1 Express Service Code and Service Tag 1 Microsoft® Windows® License Label 	<p>Express Service Code and Product Key Label</p> <p>These labels are located on your computer.</p> 
<ul style="list-style-type: none"> 1 Latest drivers for my computer 1 Answers to technical service and support questions 1 Online discussions with other users and technical support 1 Documentation for my computer 	<p>Dell Support Website — support.dell.com</p> <p>The Dell Support website provides several online tools, including:</p> <ul style="list-style-type: none"> 1 Solutions — Troubleshooting hints and tips, articles from technicians, and online courses 1 Community Forum — Online discussion with other Dell customers 1 Upgrades — Upgrade information for components, such as memory, the hard drive, and the operating system 1 Customer Care — Contact information, order status, warranty, and repair information 1 Downloads — Drivers, patches, and software updates 1 Reference — Computer documentation, product specifications, and white papers
<ul style="list-style-type: none"> 1 Service call status and support history 1 Top technical issues for my computer 1 Frequently asked questions 1 File downloads 1 Details on my computer configuration 1 Service contract for my computer 	<p>Dell Premier Support Website — premiersupport.dell.com</p> <p>The Dell Premier Support website is customized for corporate, government, and education customers. This website may not be available in all regions.</p>
<ul style="list-style-type: none"> 1 How to use Windows XP 1 Documentation for my computer 1 Documentation for devices (such as a modem) 	<p>Windows Help and Support Center</p> <ol style="list-style-type: none"> 1. Click the Start button and click Help and Support. 2. Type a word or phrase that describes your problem and click the arrow icon.

	<ol style="list-style-type: none">3. Click the topic that describes your problem.4. Follow the instructions on the screen.
1. How to reinstall my operating system	<p>Operating System CD</p> <p>After you reinstall your operating system using the Operating System Reinstallation CD, use the <i>Drivers and Utilities</i> CD to reinstall drivers for the devices that came with your computer.</p> <p>The product key for your operating system is located on your computer.</p>  A blue CD-ROM with white text. The text on the CD includes "OPERATING SYSTEM", "ALLIANT PC-CLUSTER FOR POWER COMPUTERS", "Operating System Reinstallation CD", "Product Key", "Drivers and Utilities", and "D-1011".

[Back to Contents Page](#)

[Back to Contents Page](#)

Getting Help

Dell™ OptiPlex™ SX270 Systems User's Guide

- [Technical Assistance](#)
 - [Problems With Your Order](#)
 - [Product Information](#)
 - [Returning Items for Warranty Repair or Credit](#)
 - [Before You Call](#)
 - [Contacting Dell](#)
-

Technical Assistance

If you need help with a technical problem, Dell is ready to assist you.

⚠ CAUTION: If you need to remove the computer covers, first disconnect the computer power and modem cables from all electrical outlets.

1. Complete the procedures in "[Solving Problems](#)."
2. Run the [Dell Diagnostics](#).
3. Make a copy of the [Diagnostics Checklist](#) and fill it out.
4. Use Dell's extensive suite of online services available at Dell Support (support.dell.com) for help with installation and troubleshooting procedures.
5. If the preceding steps have not resolved the problem, contact Dell.

NOTE: Call technical support from a telephone near or at the computer so that technical support can assist you with any necessary procedures.

NOTE: Dell's Express Service Code system may not be available in all countries.

When prompted by Dell's automated telephone system, enter your Express Service Code to route the call directly to the proper support personnel. If you do not have an Express Service Code, open the **Dell Accessories** folder, double-click the **Express Service Code** icon, and follow the directions.

For instructions on using the technical support service, see "[Technical Support Service](#)."

NOTE: Some of the following services are not always available in all locations outside the continental U.S. Call your local Dell representative for information on availability.

Online Services

You can access Dell Support at support.dell.com. Select your region on the **WELCOME TO DELL SUPPORT** page, and fill in the requested details to access help tools and information.

You can contact Dell electronically using the following addresses:

- 1 World Wide Web

www.dell.com/

www.dell.com/ap/ (for Asian/Pacific countries only)

www.euro.dell.com (for Europe only)

www.dell.com/la/ (for Latin American countries)

- 1 Anonymous file transfer protocol (FTP)

[ftp.dell.com/](ftp://ftp.dell.com/)

Log in as user: `anonymous`, and use your e-mail address as your password.

- 1 Electronic Support Service

mobile_support@us.dell.com

support@us.dell.com

apsupport@dell.com (for Asian/Pacific countries only)

support.euro.dell.com (for Europe only)

- 1 Electronic Quote Service

sales@dell.com

apmarketing@dell.com (for Asian/Pacific countries only)

AutoTech Service

Dell's automated technical support service—AutoTech—provides recorded answers to the questions most frequently asked by Dell customers about their portable and desktop computers.

When you call AutoTech, use your touch-tone telephone to select the subjects that correspond to your questions.

The AutoTech service is available 24 hours a day, 7 days a week. You can also access this service through the technical support service. For the telephone number to call, see the [contact numbers](#) for your region.

Automated Order-Status Service

To check on the status of any Dell™ products that you have ordered, you can go to support.dell.com, or you can call the automated order-status service. A recording prompts you for the information needed to locate and report on your order. For the telephone number to call, see the [contact numbers](#) for your region.

Technical Support Service

Dell's technical support service is available 24 hours a day, 7 days a week, to answer your questions about Dell hardware. Our technical support staff uses computer-based diagnostics to provide fast, accurate answers.

To contact Dell's technical support service, see "[Technical Assistance](#)" and then call the number for your country as listed in "[Contacting Dell](#)."

Problems With Your Order

If you have a problem with your order, such as missing parts, wrong parts, or incorrect billing, contact Dell for customer assistance. Have your invoice or packing slip handy when you call. For the telephone number to call, see the [contact numbers](#) for your region.

Product Information

If you need information about additional products available from Dell, or if you would like to place an order, visit the Dell website at www.dell.com. For the telephone number to call to speak to a sales specialist, see the [contact numbers](#) for your region.

Returning Items for Warranty Repair or Credit

Prepare all items being returned, whether for repair or credit, as follows:

1. Call Dell to obtain a Return Material Authorization Number, and write it clearly and prominently on the outside of the box.
For the telephone number to call, see the [contact numbers](#) for your region.
2. Include a copy of the invoice and a letter describing the reason for the return.
3. Include a copy of the [Diagnostics Checklist](#) indicating the tests you have run and any error messages reported by the Dell Diagnostics.
4. Include any accessories that belong with the item(s) being returned (power cables, software floppy disks, guides, and so on) if the return is for credit.
5. Pack the equipment to be returned in the original (or equivalent) packing materials.

You are responsible for paying shipping expenses. You are also responsible for insuring any product returned, and you assume the risk of loss during shipment to Dell. Collect On Delivery (C.O.D.) packages are not accepted.

Returns that are missing any of the preceding requirements will be refused at Dell's receiving dock and returned to you.

Before You Call

NOTE: Have your Express Service Code ready when you call. The code helps Dell's automated-support telephone system direct your call more efficiently.

Remember to fill out the [Diagnostics Checklist](#). If possible, turn on your computer before you call Dell for technical assistance and call from a telephone at or near the computer. You may be asked to type some commands at the keyboard, relay detailed information during operations, or try other troubleshooting steps possible only at the computer itself. Ensure that the computer documentation is available.

 **CAUTION:** Before working inside your computer, read the safety instructions in steps in "[CAUTION: Safety Instructions](#)."

Diagnostics Checklist
Name:
Date:
Address:
Phone number:
Service Tag (bar code on the back of the computer):
Express Service Code:
Return Material Authorization Number (if provided by Dell support technician):
Operating system and version:
Devices:
Expansion cards:
Are you connected to a network? Yes No
Network, version, and network adapter:
Programs and versions:
See your operating system documentation to determine the contents of the system's start-up files. If the computer is connected to a printer, print each file. Otherwise, record the contents of each file before calling Dell.
Error message, beep code, or diagnostic code:
Description of problem and troubleshooting procedures you performed:

Contacting Dell

To contact Dell electronically, you can access the following websites:

- 1 www.dell.com
- 1 support.dell.com (technical support)
- 1 premiersupport.dell.com (technical support for educational, government, healthcare, and medium/large business customers, including Premier, Platinum, and Gold customers)

For specific web addresses for your country, find the appropriate country section in the table below.

NOTE: Toll-free numbers are for use within the country for which they are listed.

When you need to contact Dell, use the electronic addresses, telephone numbers, and codes provided in the following table. If you need assistance in determining which codes to use, contact a local or an international operator.

Country (City) International Access Code Country Code City Code	Department Name or Service Area, Website and E-Mail Address	Area Codes, Local Numbers, and Toll-Free Numbers
Anguilla	General Support	toll-free: 800-335-0031
Antigua and Barbuda	General Support	1-800-805-5924
Argentina (Buenos Aires)	Website: www.dell.com.ar	
International Access Code: 00	Tech Support and Customer Care	toll-free: 0-800-444-0733
Country Code: 54	Sales	0-810-444-3355
City Code: 11	Tech Support Fax	11 4515 7139
	Customer Care Fax	11 4515 7138
Aruba	General Support	toll-free: 800-1578
Australia (Sydney)	E-mail (Australia): au_tech_support@dell.com	
International Access Code: 0011	E-mail (New Zealand): nz_tech_support@dell.com	
Country Code: 61	Home and Small Business	1-300-65-55-33
City Code: 2	Government and Business	toll-free: 1-800-633-559
	Preferred Accounts Division (PAD)	toll-free: 1-800-060-889
	Customer Care	toll-free: 1-800-819-339
	Corporate Sales	toll-free: 1-800-808-385
	Transaction Sales	toll-free: 1-800-808-312
	Fax	toll-free: 1-800-818-341
Austria (Vienna)	Website: support.euro.dell.com	
International Access Code: 900	E-mail: tech_support_central_europe@dell.com	
Country Code: 43	Home/Small Business Sales	01 795 67602
	Home/Small Business Fax	01 795 67605

City Code: 1	Home/Small Business Customer Care	01 795 67603
	Preferred Accounts/Corporate Customer Care	0660 8056
	Home/Small Business Technical Support	01 795 67604
	Preferred Accounts/Corporate Technical Support	0660 8779
	Switchboard	01 491 04 0
Bahamas	General Support	toll-free: 1-866-278-6818
Barbados	General Support	1-800-534-3066
Belgium (Brussels) International Access Code: 00 Country Code: 32 City Code: 2	Website: support.euro.dell.com	
	E-mail: tech_be@dell.com	
	E-mail for French Speaking Customers: support.euro.dell.com/be/fr/emaildell/	
	Technical Support	02 481 92 88
	Customer Care	02 481 91 19
	Home/Small Business Sales	toll-free: 0800 16884
	Corporate Sales	02 481 91 00
	Fax	02 481 92 99
Switchboard	02 481 91 00	
Bermuda	General Support	1-800-342-0671
Bolivia	General Support	toll-free: 800-10-0238
Brazil International Access Code: 00 Country Code: 55 City Code: 51	Website: www.dell.com/br	
	Customer Support, Technical Support	0800 90 3355
	Tech Support Fax	51 481 5470
	Customer Care Fax	51 481 5480
	Sales	0800 90 3390
British Virgin Islands	General Support	toll-free: 1-866-278-6820
Brunei Country Code: 673	Customer Technical Support (Penang, Malaysia)	604 633 4966
	Customer Service (Penang, Malaysia)	604 633 4949
	Transaction Sales (Penang, Malaysia)	604 633 4955
Canada (North York, Ontario) International Access Code: 011	Automated Order-Status System	toll-free: 1-800-433-9014
	AutoTech (automated technical support)	toll-free: 1-800-247-9362
	TechFax	toll-free: 1-800-950-1329
	Customer Care (home/small business)	toll-free: 1-800-847-4096
	Customer Care (med./large business, government)	toll-free: 1-800-326-9463
	Technical Support (home/small business)	toll-free: 1-800-847-4096
	Technical Support (med./large bus., government)	toll-free: 1-800-847-4096
	Sales (direct sales—from outside Toronto)	toll-free: 1-800-387-5752
	Sales (direct sales—from within Toronto)	416 758-2200
	Sales (federal government, education, and medical)	toll-free: 1-800-567-7542
Cayman Islands	General Support	1-800-805-7541
Chile (Santiago) Country Code: 56 City Code: 2	Sales, Customer Support, and Technical Support	toll-free: 1230-020-4823
China (Xiamen) Country Code: 86 City Code: 592	Tech Support website: support.ap.dell.com/china	
	Tech Support E-mail: cn_support@dell.com	
	Tech Support Fax	818 1350
	Home and Small Business Technical Support	toll-free: 800 858 2437
	Corporate Accounts Technical Support	toll-free: 800 858 2333
	Customer Experience	toll-free: 800 858 2060
	Home and Small Business	toll-free: 800 858 2222
	Preferred Accounts Division	toll-free: 800 858 2062
	Large Corporate Accounts GCP	toll-free: 800 858 2055
	Large Corporate Accounts Key Accounts	toll-free: 800 858 2628
	Large Corporate Accounts North	toll-free: 800 858 2999
	Large Corporate Accounts North Government and Education	toll-free: 800 858 2955
	Large Corporate Accounts East	toll-free: 800 858 2020
	Large Corporate Accounts East Government and Education	toll-free: 800 858 2669
	Large Corporate Accounts Queue Team	toll-free: 800 858 2572
	Large Corporate Accounts South	toll-free: 800 858 2355
	Large Corporate Accounts West	toll-free: 800 858 2811

	Large Corporate Accounts Spare Parts	toll-free: 800 858 2621
Colombia	General Support	980-9-15-3978
Costa Rica	General Support	0800-012-0435
Czech Republic (Prague)	Website: support.euro.dell.com	
International Access Code: 00	E-mail: czech_dell@dell.com	
Country Code: 420	Technical Support	02 22 83 27 27
City Code: 2	Customer Care	02 22 83 27 11
	Fax	02 22 83 27 14
	TechFax	02 22 83 27 28
	Switchboard	02 22 83 27 11
Denmark (Copenhagen)	Website: support.euro.dell.com	
International Access Code: 00	E-mail Support (portable computers): den_nbk_support@dell.com	
Country Code: 45	E-mail Support (desktop computers): den_support@dell.com	
	E-mail Support (servers): Nordic_server_support@dell.com	
	Technical Support	7023 0182
	Customer Care (Relational)	7023 0184
	Home/Small Business Customer Care	3287 5505
	Switchboard (Relational)	3287 1200
	Fax Switchboard (Relational)	3287 1201
	Switchboard (Home/Small Business)	3287 5000
	Fax Switchboard (Home/Small Business)	3287 5001
Dominica	General Support	toll-free: 1-866-278-6821
Dominican Republic	General Support	1-800-148-0530
Ecuador	General Support	toll-free: 999-119
El Salvador	General Support	01-899-753-0777
Finland (Helsinki)	Website: support.euro.dell.com	
International Access Code: 990	E-mail: fin_support@dell.com	
Country Code: 358	E-mail Support (servers): Nordic_support@dell.com	
City Code: 9	Technical Support	09 253 313 60
	Technical Support Fax	09 253 313 81
	Relational Customer Care	09 253 313 38
	Home/Small Business Customer Care	09 693 791 94
	Fax	09 253 313 99
	Switchboard	09 253 313 00
France (Paris) (Montpellier)	Website: support.euro.dell.com	
International Access Code: 00	E-mail: support.euro.dell.com/fr/fr/emaildell/	
Country Code: 33	Home and Small Business	
City Codes: (1) (4)	Technical Support	0825 387 270
	Customer Care	0825 823 833
	Switchboard	0825 004 700
	Switchboard (calls from outside of France)	04 99 75 40 00
	Sales	0825 004 700
	Fax	0825 004 701
	Fax (calls from outside of France)	04 99 75 40 01
	Corporate	
	Technical Support	0825 004 719
	Customer Care	0825 338 339
	Switchboard	01 55 94 71 00
	Sales	01 55 94 71 00
	Fax	01 55 94 71 01
Germany (Langen)	Website: support.euro.dell.com	
International Access Code: 00	E-mail: tech_support_central_europe@dell.com	
Country Code: 49	Technical Support	06103 766-7200
City Code: 6103	Home/Small Business Customer Care	0180-5-224400
	Global Segment Customer Care	06103 766-9570
	Preferred Accounts Customer Care	06103 766-9420
	Large Accounts Customer Care	06103 766-9560
	Public Accounts Customer Care	06103 766-9555
	Switchboard	06103 766-7000

Grenada	General Support	toll-free: 1-866-540-3355
Guatemala	General Support	1-800-999-0136
Guyana	General Support	toll-free: 1-877-270-4609
Hong Kong International Access Code: 001 Country Code: 852	Technical Support (Dimension™ and Inspiron™)	296 93188
	Technical Support (OptiPlex™, Latitude™, and Dell Precision™)	296 93191
	Customer Service (non-technical, post-sales issues)	800 93 8291
	Transaction Sales	toll-free: 800 96 4109
	Large Corporate Accounts HK	toll-free: 800 96 4108
	Large Corporate Accounts GCP HK	toll-free: 800 90 3708
India	Technical Support	1600 33 8045
	Sales	1600 33 8044
Ireland (Cherrywood) International Access Code: 16 Country Code: 353 City Code: 1	Website: support.euro.dell.com	
	E-mail: dell_direct_support@dell.com	
	Ireland Technical Support	1850 543 543
	U.K. Technical Support (dial within U.K. only)	0870 908 0800
	Home User Customer Care	01 204 4095
	Small Business Customer Care	01 204 4444
	U.K. Customer Care (dial within U.K. only)	0870 906 0010
	Corporate Customer Care	01 204 4003
	Ireland Sales	01 204 4444
	U.K. Sales (dial within U.K. only)	0870 907 4000
	SalesFax	01 204 0144
	Fax	01 204 5960
Switchboard	01 204 4444	
Italy (Milan) International Access Code: 00 Country Code: 39 City Code: 02	Website: support.euro.dell.com	
	E-mail: support.euro.dell.com/it/it/emaildell/	
	Home and Small Business	
	Technical Support	02 577 826 90
	Customer Care	02 696 821 14
	Fax	02 696 821 13
	Switchboard	02 696 821 12
	Corporate	
	Technical Support	02 577 826 90
	Customer Care	02 577 825 55
	Fax	02 575 035 30
	Switchboard	02 577 821
Jamaica	General Support (dial from within Jamaica only)	1-800-682-3639
Japan (Kawasaki) International Access Code: 001 Country Code: 81 City Code: 44	Website: support.jp.dell.com	
	Technical Support (servers)	toll-free: 0120-198-498
	Technical Support outside of Japan (servers)	81-44-556-4162
	Technical Support (Dimension™ and Inspiron™)	toll-free: 0120-198-226
	Technical Support outside of Japan (Dimension and Inspiron)	81-44-520-1435
	Technical Support (Dell Precision™, OptiPlex™, and Latitude™)	toll-free: 0120-198-433
	Technical Support outside of Japan (Dell Precision, OptiPlex, and Latitude)	81-44-556-3894
	24-Hour Automated Order Service	044-556-3801
	Customer Care	044-556-4240
	Business Sales Division (up to 400 employees)	044-556-1465
	Preferred Accounts Division Sales (over 400 employees)	044-556-3433
	Large Corporate Accounts Sales (over 3500 employees)	044-556-3430
	Public Sales (government agencies, educational institutions, and medical institutions)	044-556-1469
	Global Segment Japan	044-556-3469
	Individual User	044-556-1760
Faxbox Service	044-556-3490	
Switchboard	044-556-4300	
Korea (Seoul) International Access Code: 001 Country Code: 82	Technical Support	toll-free: 080-200-3800
	Sales	toll-free: 080-200-3600
	Customer Service (Seoul, Korea)	toll-free: 080-200-3800
	Customer Service (Penang, Malaysia)	604 633 4949

City Code: 2	Fax	2194-6202
	Switchboard	2194-6000
Latin America	Customer Technical Support (Austin, Texas, U.S.A.)	512 728-4093
	Customer Service (Austin, Texas, U.S.A.)	512 728-3619
	Fax (Technical Support and Customer Service) (Austin, Texas, U.S.A.)	512 728-3883
	Sales (Austin, Texas, U.S.A.)	512 728-4397
	SalesFax (Austin, Texas, U.S.A.)	512 728-4600 or 512 728-3772
Luxembourg International Access Code: 00 Country Code: 352	Website: support.euro.dell.com	
	E-mail: tech_be@dell.com	
	Technical Support (Brussels, Belgium)	02 481 92 88
	Home/Small Business Sales (Brussels, Belgium)	toll-free: 080016884
	Corporate Sales (Brussels, Belgium)	02 481 91 00
	Customer Care (Brussels, Belgium)	02 481 91 19
	Fax (Brussels, Belgium)	02 481 92 99
	Switchboard (Brussels, Belgium)	02 481 91 00
Macao Country Code: 853	Technical Support	toll-free: 0800 582
	Customer Service (Penang, Malaysia)	604 633 4949
	Transaction Sales	toll-free: 0800 581
Malaysia (Penang) International Access Code: 00 Country Code: 60 City Code: 4	Technical Support	toll-free: 1 800 888 298
	Customer Service	04 633 4949
	Transaction Sales	toll-free: 1 800 888 202
	Corporate Sales	toll-free: 1 800 888 213
Mexico International Access Code: 00 Country Code: 52	Customer Technical Support	001-877-384-8979 or 001-877-269-3383
	Sales	50-81-8800 or 01-800-888-3355
	Customer Service	001-877-384-8979 or 001-877-269-3383
	Main	50-81-8800 or 01-800-888-3355
Montserrat	General Support	toll-free: 1-866-278-6822
Netherlands Antilles	General Support	001-800-882-1519
Netherlands (Amsterdam) International Access Code: 00 Country Code: 31 City Code: 20	Website: support.euro.dell.com	
	E-mail (Technical Support):	
	(Enterprise): nl_server_support@dell.com	
	(Latitude): nl_latitude_support@dell.com	
	(Inspiron): nl_inspiron_support@dell.com	
	(Dimension): nl_dimension_support@dell.com	
	(OptiPlex): nl_optiplex_support@dell.com	
	(Dell Precision): nl_workstation_support@dell.com	
	Technical Support	020 674 45 00
	Technical Support Fax	020 674 47 66
	Home/Small Business Customer Care	020 674 42 00
	Relational Customer Care	020 674 4325
	Home/Small Business Sales	020 674 55 00
	Relational Sales	020 674 50 00
	Home/Small Business Sales Fax	020 674 47 75
Relational Sales Fax	020 674 47 50	
Switchboard	020 674 50 00	
Switchboard Fax	020 674 47 50	
New Zealand International Access Code: 00	E-mail (New Zealand): nz_tech_support@dell.com	
	E-mail (Australia): au_tech_support@dell.com	

Country Code: 64	Home and Small Business	0800 446 255
	Government and Business	0800 444 617
	Sales	0800 441 567
	Fax	0800 441 566
Nicaragua	General Support	001-800-220-1006
Norway (Lysaker) International Access Code: 00 Country Code: 47	Website: support.euro.dell.com	
	E-mail Support (portable computers): nor_nbk_support@dell.com	
	E-mail Support (desktop computers): nor_support@dell.com	
	E-mail Support (servers): nordic_server_support@dell.com	
	Technical Support	671 16882
	Relational Customer Care	671 17514
	Home/Small Business Customer Care	23162298
	Switchboard	671 16800
	Fax Switchboard	671 16865
	Panama	General Support
Peru	General Support	0800-50-669
Poland (Warsaw) International Access Code: 011 Country Code: 48 City Code: 22	Website: support.euro.dell.com	
	E-mail: pl_support@dell.com	
	Customer Service Phone	57 95 700
	Customer Care	57 95 999
	Sales	57 95 999
	Customer Service Fax	57 95 806
	Reception Desk Fax	57 95 998
	Switchboard	57 95 999
Portugal International Access Code: 00 Country Code: 35	E-mail: support.euro.dell.com/es/es/emaildell/	
	Technical Support	800 834 077
	Customer Care	800 300 415 or 800 834 075
	Sales	800 300 410 or 800 300 411 or 800 300 412 or 121 422 07 10
	Fax	121 424 01 12
Puerto Rico	General Support	1-800-805-7545
St. Kitts and Nevis	General Support	toll-free: 1-877-441-4731
St. Lucia	General Support	1-800-882-1521
St. Vincent and the Grenadines	General Support	toll-free: 1-877-270-4609
Singapore (Singapore) International Access Code: 005 Country Code: 65	Technical Support	toll-free: 800 6011 051
	Customer Service (Penang, Malaysia)	604 633 4949
	Transaction Sales	toll-free: 800 6011 054
	Corporate Sales	toll-free: 800 6011 053
South Africa (Johannesburg) International Access Code: 09/091 Country Code: 27 City Code: 11	Website: support.euro.dell.com	
	E-mail: dell_za_support@dell.com	
	Technical Support	011 709 7710
	Customer Care	011 709 7707
	Sales	011 709 7700
	Fax	011 706 0495
	Switchboard	011 709 7700
Southeast Asian and Pacific Countries	Customer Technical Support, Customer Service, and Sales (Penang, Malaysia)	604 633 4810
Spain (Madrid) International Access Code: 00 Country Code: 34 City Code: 91	Website: support.euro.dell.com	
	E-mail: support.euro.dell.com/es/es/emaildell/	
	Home and Small Business	
	Technical Support	902 100 130
	Customer Care	902 118 540
	Sales	902 118 541
Switchboard	902 118 541	

	Fax	902 118 539
	Corporate	
	Technical Support	902 100 130
	Customer Care	902 118 546
	Switchboard	91 722 92 00
	Fax	91 722 95 83
Sweden (Upplands Vasby)	Website: support.euro.dell.com	
International Access Code: 00	E-mail: swe_support@dell.com	
Country Code: 46	E-mail Support for Latitude and Inspiron: Swe-nbk_kats@dell.com	
City Code: 8	E-mail Support for OptiPlex: Swe_kats@dell.com	
	E-mail Support for Servers: Nordic_server_support@dell.com	
	Technical Support	08 590 05 199
	Relational Customer Care	08 590 05 642
	Home/Small Business Customer Care	08 587 70 527
	Employee Purchase Program (EPP) Support	20 140 14 44
	Fax Technical Support	08 590 05 594
	Sales	08 590 05 185
Switzerland (Geneva)	Website: support.euro.dell.com	
International Access Code: 00	E-mail: swisstech@dell.com	
Country Code: 41	E-mail for French-speaking HSB and Corporate Customers: support.euro.dell.com/ch/fr/emaildell/	
City Code: 22	Technical Support (Home and Small Business)	0844 811 411
	Technical Support (Corporate)	0844 822 844
	Customer Care (Home and Small Business)	0848 802 202
	Customer Care (Corporate)	0848 821 721
	Fax	022 799 01 90
	Switchboard	022 799 01 01
Taiwan	Technical Support (portable and desktop computers)	toll-free: 00801 86 1011
International Access Code: 002	Technical Support (servers)	toll-free: 0080 60 1256
Country Code: 886	Transaction Sales	toll-free: 0080 651 228 or 0800 33 556
	Corporate Sales	toll-free: 0080 651 227 or 0800 33 555
Thailand	Technical Support	toll-free: 0880 060 07
International Access Code: 001	Customer Service (Penang, Malaysia)	604 633 4949
Country Code: 66	Sales	toll-free: 0880 060 09
Trinidad/Tobago	General Support	1-800-805-8035
Turks and Caicos Islands	General Support	toll-free: 1-866-540-3355
U.K. (Bracknell)	Website: support.euro.dell.com	
International Access Code: 00	Customer Care website: dell.co.uk/lca/customerservices	
Country Code: 44	E-mail: dell_direct_support@dell.com	
City Code: 1344	Technical Support (Corporate/Preferred Accounts/PAD [1000+ employees])	0870 908 0500
	Technical Support (direct/PAD and general)	0870 908 0800
	Global Accounts Customer Care	01344 373 185 or 01344 373 186
	Home and Small Business Customer Care	0870 906 0010
	Corporate Customer Care	0870 908 0500
	Preferred Accounts (500–5000 employees) Customer Care	01344 373 196
	Central Government Customer Care	01344 373 193
	Local Government & Education Customer Care	01344 373 199
	Health Customer Care	01344 373 194
	Home and Small Business Sales	0870 907 4000
	Corporate/Public Sector Sales	01344 860 456
Uruguay	General Support	toll-free: 000-413-598-2521
U.S.A. (Austin, Texas)	Automated Order-Status Service	toll-free: 1-800-433-9014
International Access Code:	AutoTech (portable and desktop computers)	toll-free: 1-800-247-9362

011

Country Code: 1

Consumer (Home and Home Office)	
Technical Support	toll-free: 1-800-624-9896
Customer Service	toll-free: 1-800-624-9897
DellNet™ Service and Support	toll-free: 1-877-Dellnet (1-877-335-5638)
Employee Purchase Program (EPP) Customers	toll-free: 1-800-695-8133
Financial Services website: www.dellfinancialservices.com	
Financial Services (lease/loans)	toll-free: 1-877-577-3355
Financial Services (Dell Preferred Accounts [DPA])	toll-free: 1-800-283-2210
Business	
Customer Service and Technical Support	toll-free: 1-800-822-8965
Employee Purchase Program (EPP) Customers	toll-free: 1-800-695-8133
Projectors Technical Support	toll-free: 1-877-459-7298
Public (government, education, and healthcare)	
Customer Service and Technical Support	toll-free: 1-800-456-3355
Employee Purchase Program (EPP) Customers	toll-free: 1-800-234-1490
Dell Sales	toll-free: 1-800-289-3355 or toll-free: 1-800-879-3355
Dell Outlet Store (Dell refurbished computers)	toll-free: 1-888-798-7561
Software and Peripherals Sales	toll-free: 1-800-671-3355
Spare Parts Sales	toll-free: 1-800-357-3355
Extended Service and Warranty Sales	toll-free: 1-800-247-4618
Fax	toll-free: 1-800-727-8320
Dell Services for the Deaf, Hard-of-Hearing, or Speech-Impaired	toll-free: 1-877-DELLTTY (1-877-335-5889)
U.S. Virgin Islands	General Support 1-877-673-3355
Venezuela	General Support 8001-3605

[Back to Contents Page](#)

[Back to Contents Page](#)

Glossary

Dell™ OptiPlex™ SX270 Systems User's Guide

[A](#) [B](#) [C](#) [D](#) [E](#) [F](#) [G](#) [H](#) [I](#) [J](#) [K](#) [L](#) [M](#) [N](#) [O](#) [P](#) [R](#) [S](#) [T](#) [U](#) [V](#) [W](#) [X](#) [Z](#)

Terms in this Glossary are provided for informational purposes only and may or may not describe features included with your particular computer.

A

AC — alternating current — The form of electricity that powers your computer when you plug the AC adapter power cable in to an electrical outlet.

ACPI — advanced configuration and power interface — A power management specification that enables Microsoft® Windows® operating systems to put a computer in standby or hibernate mode to conserve the amount of electrical power allocated to each device attached to the computer.

AGP — accelerated graphics port — A dedicated graphics port that allows system memory to be used for video-related tasks. AGP delivers a smooth, true-color video image because of the faster interface between the video circuitry and the computer memory.

antivirus software — A program designed to identify, quarantine, and/or delete viruses from your computer.

APR — advanced port replicator — A docking device that allows you to conveniently use a monitor, keyboard, mouse, and other devices with your portable computer.

ASF — alert standards format — A standard to define a mechanism for reporting hardware and software alerts to a management console. ASF is designed to be platform- and operating system-independent.

B

backup — A copy of a program or data file on a floppy disk, CD, or hard drive. As a precaution, back up the data files from your hard drive regularly.

battery — An internal power source used to operate portable computers when not connected to an AC adapter and an electrical outlet.

battery life span — The length of time (years) during which a portable computer battery is able to be depleted and recharged.

battery operating time — The length of time (minutes or hours) that a portable computer battery holds a charge while powering the computer.

BIOS — basic input/output system — A program (or utility) that serves as an interface between the computer hardware and the operating system. Unless you understand what effect the settings have on the computer, do not change the settings for this program. Also referred to as the *system setup program*.

bit — The smallest unit of data interpreted by your computer.

Bluetooth™ — A wireless technology standard for short-range (9 m [29 feet]) networking devices that allows for enabled devices to automatically recognize each other.

boot sequence — Specifies the order of the devices from which the computer attempts to boot.

bootable CD — A CD that you can use to start your computer. In case your hard drive is damaged or your computer has a virus, ensure that you always have a bootable CD or floppy disk available. Your *Drivers and Utilities* or ResourceCD is a bootable CD.

bootable disk — A disk that you can use to start your computer. In case your hard drive is damaged or your computer has a virus, ensure that you always have a bootable CD or floppy disk available.

bps — bits per second — The standard unit for measuring data transmission speed.

BTU — British thermal unit — A measurement of heat output.

bus — A communication pathway between the components in your computer.

bus speed — The speed, given in MHz, that indicates how fast a bus can transfer information.

byte — The basic data unit used by your computer. A byte is usually equal to 8 bits.

C

C — Celsius — A temperature measurement system where 0° is the freezing point and 100° is the boiling point of water.

cache — A special high-speed storage mechanism which can be either a reserved section of main memory or an independent high-speed storage device. The cache enhances the efficiency of many microprocessor operations.

L1 cache — Primary cache stored inside the microprocessor.

L2 cache — Secondary cache which can either be external to the microprocessor or incorporated into the microprocessor architecture.

carnet — An international customs document that facilitates temporary imports into foreign countries. Also known as a *merchandise passport*.

CD — compact disc — An optical form of storage media, typically used for audio and software programs.

CD drive — A drive that uses optical technology to read data from CDs.

CD player — The software used to play music CDs. The CD player displays a window with buttons that you use to play a CD.

CD-R — CD recordable — A recordable version of a CD. Data can be recorded only once onto a CD-R. Once recorded, the data cannot be erased or written over.

CD-RW — CD rewritable — A rewritable version of a CD. Data can be written to a CD-RW disc, and then erased and written over (rewritten).

CD-RW drive — A drive that can read CDs and write to CD-RW (rewritable CDs) and CD-R (recordable CDs) discs. You can write to CD-RW discs multiple times, but you can write to CD-R discs only once.

CD-RW/DVD drive — A drive, sometimes referred to as a combo drive, that can read CDs and DVDs and write to CD-RW (rewritable CDs) and CD-R (recordable CDs) discs. You can write to CD-RW discs multiple times, but you can write to CD-R discs only once.

clock speed — The speed, given in MHz, that indicates how fast computer components that are connected to the system bus operate.

COA — Certificate of Authenticity — The Windows alpha-numeric code located on a sticker on your computer. You may need the COA to complete the operating system setup or reinstallation. Also referred to as the *Product Key* or *Product ID*.

Control Panel — A Windows utility that allows you to modify operating system and hardware settings, such as display settings.

controller — A chip that controls the transfer of data between the microprocessor and memory or between the microprocessor and devices.

CRIMM — continuity rambus in-line memory module — A special module that has no memory chips and is used to fill unused RIMM slots.

cursor — The marker on a display or screen that shows where the next keyboard, touch pad, or mouse action will occur. It often is a blinking solid line, an underline character, or a small arrow.

D

DDR SDRAM — double-data-rate SDRAM — A type of SDRAM that doubles the data burst cycle, improving system performance.

device — Hardware such as a disk drive, printer, or keyboard that is installed in or connected to your computer.

device driver — See *driver*.

DIN connector — A round, six-pin connector that conforms to DIN (Deutsche Industrie-Norm) standards; it is typically used to connect PS/2 keyboard or mouse cable connectors.

disk striping — A technique for spreading data over multiple disk drives. Disk striping can speed up operations that retrieve data from disk storage. Computers that use disk striping generally allow the user to select the data unit size or stripe width.

DMA — direct memory access — A channel that allows certain types of data transfer between RAM and a device to bypass the microprocessor.

docking device — See *APR*.

DMTF — Distributed Management Task Force — A consortium of hardware and software companies who develop management standards for distributed desktop, network, enterprise, and Internet environments.

domain — A group of computers, programs, and devices on a network that are administered as a unit with common rules and procedures for use by a specific group of users. A user logs on to the domain to gain access to the resources.

DRAM — dynamic random-access memory — Memory that stores information in integrated circuits containing capacitors.

driver — Software that allows the operating system to control a device such as a printer. Many devices do not work properly if the correct driver is not installed in the computer.

DSL — Digital Subscriber Line — A technology that provides a constant, high-speed Internet connection through an analog telephone line.

dual display mode — A display setting that allows you to use a second monitor as an extension of your display. Also referred to as *extended display mode*.

DVD — digital versatile disc — A disc usually used to store movies. DVDs are double-sided, whereas CDs are single-sided. DVD drives read most CD media as well.

DVD drive — A drive that uses optical technology to read data from DVDs and CDs.

DVD player — The software used to watch DVD movies. The DVD player displays a window with buttons that you use to watch a movie.

DVD+RW — DVD rewritable — A rewritable version of a DVD. Data can be written to a DVD+RW disc, and then erased and written over (rewritten). (DVD+RW technology is different from DVD-RW technology.)

DVD+RW drive — A drive that can read DVDs and most CD media and write to DVD+RW (rewritable DVDs) discs.

DVI — digital video interface — A standard for digital transmission between a computer and a digital video display; the DVI adapter works through the computer's integrated graphics.

E

ECC — error checking and correction — A type of memory that includes special circuitry for testing the accuracy of data as it passes in and out of memory.

ECP — extended capabilities port — A parallel connector design that provides improved bidirectional data transmission. Similar to EPP, ECP uses direct memory access to transfer data and often improves performance.

EIDE — enhanced integrated device electronics — An improved version of the IDE interface for hard drives and CD drives.

EMI — electromagnetic interference — Electrical interference caused by electromagnetic radiation.

ENERGY STAR® — Environmental Protection Agency requirements that decrease the overall consumption of electricity.

EPP — enhanced parallel port — A parallel connector design that provides bidirectional data transmission.

ESD — electrostatic discharge — A rapid discharge of static electricity. ESD can damage integrated circuits found in computer and communications equipment.

expansion card — A circuit board that installs in an expansion slot on the system board in some computers, expanding the capabilities of the computer. Examples include video, modem, and sound cards.

expansion slot — A connector on the system board (in some computers) where you insert an expansion card, connecting it to the system bus.

Express Service Code — A numeric code located on a sticker on your Dell™ computer. Use the Express Service Code when contacting Dell for assistance. Express Service Code service may not be available in some countries.

extended display mode — A display setting that allows you to use a second monitor as an extension of your display. Also referred to as *dual display mode*.

extended PC Card — A PC Card that extends beyond the edge of the PC Card slot when installed.

 **NOTE:** If your computer has two PC Card connectors, always install extended PC Cards in the top connector.

 **NOTICE:** Always remove an extended PC Card before packing the computer or traveling. If something strikes the exposed end of the PC Card, the system board may be damaged.

F

Fahrenheit — A temperature measurement system where 32° is the freezing point and 212° is the boiling point of water.

FCC — Federal Communications Commission — A U.S. agency responsible for enforcing communications-related regulations that state how much radiation computers and other electronic equipment can emit.

floppy drive — A disk drive that can read and write to floppy disks.

folder — A term used to describe space on a disk or drive where files are organized and grouped. Files in a folder can be viewed and ordered in various ways, such as alphabetically, by date, and by size.

format — The process that prepares a drive or disk for file storage. When a drive or disk is formatted, the existing information on it is lost.

FSB — front side bus — The data path and physical interface between the microprocessor and RAM.

FTP — file transfer protocol — A standard Internet protocol used to exchange files between computers connected to the Internet.

G

G — gravity — A measurement of weight and force.

GB — gigabyte — A measurement of data storage that equals 1024 MB (1,073,741,824 bytes). When used to refer to hard drive storage, the term is often rounded to 1,000,000,000 bytes.

GHz — gigahertz — A measurement of frequency that equals one thousand million Hz, or one thousand MHz. The speeds for computer microprocessors, buses, and interfaces are often measured in GHz.

graphics mode — A video mode that can be defined as x horizontal pixels by y vertical pixels by z colors. Graphics modes can display an unlimited variety of shapes and fonts.

GUI — graphical user interface — Software that interacts with the user by means of menus, windows, and icons. Most programs that operate on the Windows operating systems are GUIs.

H

hard drive — A drive that reads and writes data on a hard disk. The terms hard drive and hard disk are often used interchangeably.

heat sink — A metal plate on some microprocessors that helps dissipate heat.

help file — A file that contains descriptive or instructional information about a product. Some help files are associated with a particular program, such as *Help* in Microsoft Word. Other help files function as stand-alone reference sources. Help files typically have a filename extension of **.hlp** or **.chm**.

hibernate mode — A power management mode that saves everything in memory to a reserved space on the hard drive and then turns off the computer. When you restart the computer, the memory information that was saved to the hard drive is automatically restored.

HTML — hypertext markup language — A set of codes inserted into an Internet web page intended for display on an Internet browser.

HTTP — hypertext transfer protocol — A protocol for exchanging files between computers connected to the Internet.

Hz — hertz — A unit of frequency measurement that equals 1 cycle per second. Computers and electronic devices are often measured in kilohertz (kHz), megahertz (MHz), gigahertz (GHz), or terahertz (THz).

I

IC — Industry Canada — The Canadian regulatory body responsible for regulating emissions from electronic equipment, much as the FCC does in the United States.

IC — integrated circuit — A semiconductor wafer, or chip, on which thousands or millions of tiny electronic components are fabricated for use in computer, audio, and video equipment.

IDE — integrated device electronics — An interface for mass storage devices in which the controller is integrated into the hard drive or CD drive.

IEEE 1394 — Institute of Electrical and Electronics Engineers, Inc. — A high-performance serial bus used to connect IEEE 1394-compatible devices, such as digital cameras and DVD players, to the computer.

infrared sensor — A port that allows you to transfer data between the computer and infrared-compatible devices without using a cable connection.

integrated — Usually refers to components that are physically located on the computer's system board. Also referred to as *built-in*.

I/O — input/output — An operation or device that enters and extracts data from your computer. Keyboards and printers are I/O devices.

I/O address — An address in RAM that is associated with a specific device (such as a serial connector, parallel connector, or expansion slot) and allows the microprocessor to communicate with that device.

IrDA — Infrared Data Association — The organization that creates international standards for infrared communications.

IRQ — interrupt request — An electronic pathway assigned to a specific device so that the device can communicate with the microprocessor. Each device connection must be assigned an IRQ. Although two devices can share the same IRQ assignment, you cannot operate both devices simultaneously.

ISP — Internet service provider — A company that allows you to access its host server to connect directly to the Internet, send and receive e-mail, and access websites. The ISP typically provides you with a software package, user name, and access phone numbers for a fee.

K

Kb — kilobit — A unit of data that equals 1024 bits. A measurement of the capacity of memory integrated circuits.

KB — kilobyte — A unit of data that equals 1024 bytes but is often referred to as 1000 bytes.

keyboard shortcut — A command requiring you to press multiple keys at the same time. Also referred to as a *key combination*.

kHz — kilohertz — A measurement of frequency that equals 1000 Hz.

L

LAN — local area network — A computer network covering a small area. A LAN usually is confined to a building or a few nearby buildings. A LAN can be connected to another LAN over any distance through telephone lines and radio waves to form a wide area network (WAN).

LCD — liquid crystal display — The technology used by portable computer and flat-panel displays.

LED — light-emitting diode — An electronic component that emits light to indicate the status of the computer.

local bus — A data bus that provides a fast throughput for devices to the microprocessor.

LPT — line print terminal — The designation for a parallel connection to a printer or other parallel device.

M

Mb — megabit — A measurement of memory chip capacity that equals 1024 Kb.

Mbps — megabits per second — One million bits per second. This measurement is typically used for transmission speeds for networks and modems.

MB — megabyte — A measurement of data storage that equals 1,048,576 bytes. 1 MB equals 1024 KB. When used to refer to hard drive storage, the term is often rounded to 1,000,000 bytes.

MB/sec — megabytes per second — One million bytes per second. This measurement is typically used for data transfer ratings.

memory — A temporary data storage area inside your computer. Because the data in memory is not permanent, it is recommended that you frequently save your files while you are working on them, and always save your files before you shut down the computer. Your computer can contain several different forms of memory, such as RAM, ROM, and video memory. Frequently, the word memory is used as a synonym for RAM.

memory address — A specific location where data is temporarily stored in RAM.

memory mapping — The process by which the computer assigns memory addresses to physical locations at start-up. Devices and software can then identify information that the microprocessor can access.

memory module — A small circuit board containing memory chips, which connects to the system board.

MHz — megahertz — A measure of frequency that equals 1 million cycles per second. The speeds for computer microprocessors, buses, and interfaces are often measured in MHz.

microprocessor — A computer chip that interprets and executes program instructions. Sometimes the microprocessor is referred to as the processor or the CPU (central processing unit).

modem — A device that allows your computer to communicate with other computers over analog telephone lines. Three types of modems include: external, PC Card, and internal. You typically use your modem to connect to the Internet and exchange e-mail.

module bay — A bay that supports devices such as optical drives, a second battery, or a Dell TravelLite™ module.

monitor — The high-resolution TV-like device that displays computer output.

mouse — A pointing device that controls the movement of the cursor on your screen. Typically you roll the mouse over a hard, flat surface to move the pointer or cursor on your screen.

ms — millisecond — A measure of time that equals one thousandth of a second. Access times of storage devices are often measured in ms.

N

network adapter — A chip that provides network capabilities. A computer may include a network adapter on its system board, or it may contain a PC Card with an adapter on it. A network adapter is also referred to as a *NIC* (network interface controller).

NIC — See *network adapter*.

notification area — The section of the Windows taskbar that contains icons for providing quick access to programs and computer functions, such as the clock, volume control, and print status. Also referred to as *system tray*.

ns — nanosecond — A measure of time that equals one billionth of a second.

NVRAM — nonvolatile random access memory — A type of memory that stores data when the computer is turned off or loses its external power source. NVRAM is used for maintaining computer configuration information such as date, time, and other system setup options that you can set.

O

Optical Drive — A drive that uses optical technology to read or write data from CDs, DVDs, or DVD+RWs. Example of optical drives include CD drives, DVD drives, CD-RW drives, and CD-RW/DVD combo drives.

P

parallel connector — An I/O port often used to connect a parallel printer to your computer. Also referred to as an *LPT port*.

partition — A physical storage area on a hard drive that is assigned to one or more logical storage areas known as logical drives. Each partition can contain multiple logical drives.

PC Card — A removable I/O card adhering to the PCMCIA standard. Modems and network adapters are common types of PC Cards.

PCI — peripheral component interconnect — PCI is a local bus that supports 32-and 64-bit data paths, providing a high-speed data path between the microprocessor and devices such as video, drives, and networks.

PCMCIA — Personal Computer Memory Card International Association — The organization that establishes standards for PC Cards.

PIN — personal identification number — A sequence of numerals and/or letters used to restrict unauthorized access to computer networks and other secure systems.

PIO — programmed input/output — A method of transferring data between two devices through the microprocessor as part of the data path.

pixel — A single point on a display screen. Pixels are arranged in rows and columns to create an image. A video resolution, such as 800 x 600, is expressed as the number of pixels across by the number of pixels up and down.

Plug-and-Play — The ability of the computer to automatically configure devices. Plug and Play provides automatic installation, configuration, and compatibility with existing hardware if the BIOS, operating system, and all devices are Plug and Play compliant.

POST — power-on self-test — Diagnostics programs, loaded automatically by the BIOS, that perform basic tests on the major computer components, such as memory, hard drives, and video. If no problems are detected during POST, the computer continues the start-up.

program — Any software that processes data for you, including spreadsheet, word processor, database, and game packages. Programs require an operating system to run.

PS/2 — personal system/2 — A type of connector for attaching a PS/2-compatible keyboard, mouse, or keypad.

PXE — pre-boot execution environment — A WfM (Wired for Management) standard that allows networked computers that do not have an operating system to be configured and started remotely.

R

RAID — redundant array of independent disks — A system of two or more drives working together for performance and fault tolerance. RAID drives are typically used on servers and high-end PCs. The three most common RAID levels are 0, 3, and 5:

- 1 Level 0: Provides data striping but no redundancy. Level 0 improves performance but does not provide fault tolerance.
- 1 Level 3: Same as Level 0, but also reserves one dedicated drive for error correction data, providing good performance and some level of fault tolerance.
- 1 Level 5: Provides data striping at the byte level and also stripe error correction information, resulting in excellent performance and good fault tolerance.

RAM — random-access memory — The primary temporary storage area for program instructions and data. Any information stored in RAM is lost when you shut

down your computer.

readme file — A text file included with a software package or hardware product. Typically, readme files provide installation information and describe new product enhancements or corrections that have not yet been documented.

read-Only — Data and/or files you can view but cannot edit or delete. A file can have read-only status if:

- 1 It resides on a physically write-protected floppy disk, CD, or DVD.
- 1 It is located on a network in a directory and the system administrator has assigned rights only to specific individuals.

refresh rate — The frequency, measured in Hz, at which your screen's horizontal lines are recharged (sometimes also referred to as its *vertical frequency*). The higher the refresh rate, the less video flicker can be seen by the human eye.

resolution — The sharpness and clarity of an image produced by a printer or displayed on a monitor. The higher the resolution, the sharper the image.

RFI — radio frequency interference — Interference that is generated at typical radio frequencies, in the range of 10 kHz to 100,000 MHz. Radio frequencies are at the lower end of the electromagnetic frequency spectrum and are more likely to have interference than the higher frequency radiations, such as infrared and light.

ROM — read-only memory — Memory that stores data and programs that cannot be deleted or written to by the computer. ROM, unlike RAM, retains its contents after you shut down your computer. Some programs essential to the operation of your computer reside in ROM.

RPM — revolutions per minute — The number of rotations that occur per minute. Hard drive speed is often measured in rpm.

RTC — real time clock — Battery-powered clock on the system board that keeps the date and time after you shut down the computer.

RTCST — real-time clock reset — A jumper on the system board of some computers that can often be used for troubleshooting problems.

S

ScanDisk — A Microsoft utility that checks files, folders, and the hard disk's surface for errors. ScanDisk often runs when you restart the computer after it has stopped responding.

SDRAM — synchronous dynamic random-access memory — A type of DRAM that is synchronized with the optimal clock speed of the microprocessor.

serial connector — An I/O port often used to connect devices such as a handheld digital device or digital camera to your computer.

Service Tag — A bar code label on your computer that identifies your computer when you access Dell Support at support.dell.com or when you call Dell for customer service or technical support.

setup program — A program that is used to install and configure hardware and software. The **setup.exe** or **install.exe** program comes with most Windows software packages. Setup program differs from system setup program.

shortcut — An icon that provides quick access to frequently used programs, files, folders, and drives. When you place a shortcut on your Windows desktop and double-click the icon, you can open its corresponding folder or file without having to find it first. Shortcut icons do not change the location of files. If you delete a shortcut, the original file is not affected. Also, you can rename a shortcut icon.

shutdown — The process of closing windows and exiting programs, exiting the operating system, and turning off your computer. You can lose data if you turn off your computer before completing a shutdown.

smart card — A card that is embedded with a microprocessor and a memory chip. Smart cards can be used to authenticate a user on computers equipped for smart cards.

software — Anything that can be stored electronically, such as computer files or programs.

S/PDIF — Sony/Philips Digital Interface — An audio transfer file format that allows the transfer of audio from one file to another without converting it to and from an analog format, which could degrade the quality of the file.

standby mode — A power management mode that shuts down all unnecessary computer operations to save energy.

surge protectors — Prevent voltage spikes, such as those that may occur during an electrical storm, from entering the computer through the electrical outlet. Surge protectors do not protect against lightning strikes or against brownouts, which occur when the voltage drops more than 20 percent below the normal AC-line voltage level.

Network connections cannot be protected by surge protectors. Always disconnect the network cable from the network connector during electrical storms.

SVGA — super-video graphics array — A video standard for video cards and controllers. Typical SVGA resolutions are 800 x 600 and 1024 x 768. The number of colors and resolution that a program displays depends on the capabilities of the monitor, the video controller and its drivers, and the amount of video memory installed in the computer.

S-video TV-out — A connector used to attach a TV or digital audio device to the computer.

SXGA — super-extended graphics array — A video standard for video cards and controllers that supports resolutions up to 1280 x 1024.

SXGA+ — super-extended graphics array plus — A video standard for video cards and controllers that supports resolutions up to 1400 x 1050.

system board — The main circuit board in your computer. Also known as the *motherboard*.

system setup program — A utility that serves as an interface between the computer hardware and the operating system. System setup allows you to configure user-selectable options in the BIOS, such as date and time or system password. Unless you understand what effect the settings have on the computer, do not change the settings for this program.

system tray — See *notification area*.

T

TAPI — telephony application programming interface — Enables Windows programs to operate with a wide variety of telephony devices, including voice, data, fax, and video.

text editor — A program used to create and edit files that contain only text; for example, Windows Notepad uses a text editor. Text editors do not usually provide word wrap or formatting functionality (the option to underline, change fonts, and so on).

travel module — A plastic device designed to fit inside the module bay of a portable computer to reduce the weight of the computer.

U

UPS — uninterruptible power supply — A backup power source used when the electrical power fails or drops to an unacceptable voltage level. A UPS keeps a computer running for a limited amount of time when there is no electrical power. UPS systems typically provide surge suppression and may also provide voltage regulation. Small UPS systems provide battery power for a few minutes to enable you to shut down your computer.

USB — universal serial bus — A hardware interface for a low-speed device such as a USB-compatible keyboard, mouse, joystick, scanner, set of speakers, printer, broadband devices (DSL and cable modems), imaging devices, or storage devices. Devices are plugged directly in to a 4-pin socket on your computer or in to a multi-port hub that plugs in to your computer. USB devices can be connected and disconnected while the computer is turned on, and they can also be daisy-chained together.

UTP — unshielded twisted pair — Describes a type of cable used in most telephone networks and some computer networks. Pairs of unshielded wires are twisted to protect against electromagnetic interference, rather than relying on a metal sheath around each pair of wires to protect against interference.

UXGA — ultra extended graphics array — A video standard for video cards and controllers that supports resolutions up to 1600 x 1200.

V

video controller — The circuitry on a video card or on the system board (in computers with an integrated video controller) that provides the video capabilities—in combination with the monitor—for your computer.

video memory — Memory that consists of memory chips dedicated to video functions. Video memory is usually faster than system memory. The amount of video memory installed primarily influences the number of colors that a program can display.

video mode — A mode that describes how text and graphics are displayed on a monitor. Graphics-based software, such as Windows operating systems, displays in video modes that can be defined as x horizontal pixels by y vertical pixels by z colors. Character-based software, such as text editors, displays in video modes that can be defined as x columns by y rows of characters.

video resolution — See *resolution*.

virus — A program that is designed to inconvenience you or to destroy data stored on your computer. A virus program moves from one computer to another through an infected disk, software downloaded from the Internet, or e-mail attachments. When an infected program starts, its embedded virus also starts.

A common type of virus is a boot virus, which is stored in the boot sectors of a floppy disk. If the floppy disk is left in the drive when the computer is shut down and then turned on, the computer is infected when it reads the boot sectors of the floppy disk expecting to find the operating system. If the computer is infected, the boot virus may replicate itself onto all the floppy disks that are read or written in that computer until the virus is eradicated.

V — volt — The measurement of electric potential or electromotive force. One V appears across a resistance of 1 ohm when a current of 1 ampere flows through that resistance.

W

W — watt — The measurement of electrical power. One W is 1 ampere of current flowing at 1 volt.

Whr — watt-hour — A unit of measure commonly used to indicate the approximate capacity of a battery. For example, a 66-Whr battery can supply 66 W of power for 1 hour or 33 W for 2 hours.

wallpaper — The background pattern or picture on the Windows desktop. Change your wallpaper through the Windows Control Panel. You can also scan in your favorite picture and make it wallpaper.

write-protected — Files or media that cannot be changed. Use write-protection when you want to protect data from being changed or destroyed. To write-protect a 3.5-inch floppy disk, slide its write-protect tab to the open position.

X

XGA — extended graphics array — A video standard for video cards and controllers that supports resolutions up to 1024 x 768.

Z

ZIF — zero insertion force — A type of socket or connector that allows a computer chip to be installed or removed with no stress applied to either the chip or its socket.

Zip — A popular data compression format. Files that have been compressed with the Zip format are called Zip files and usually have a filename extension of **.zip**. A special kind of zipped file is a self-extracting file, which has a filename extension of **.exe**. You can unzip a self-extracting file by double-clicking it.

Zip drive — A high-capacity floppy drive developed by Iomega Corporation that uses 3.5-inch removable disks called Zip disks. Zip disks are slightly larger than regular floppy disks, about twice as thick, and hold up to 100 MB of data.

[Back to Contents Page](#)

Hard Drive

Dell™ OptiPlex™ SX270 Systems User's Guide

⚠ CAUTION: Before you begin this procedure, follow the steps in "[CAUTION: Safety Instructions.](#)"

⚠ CAUTION: To guard against electrical shock, always unplug your computer from the power supply before removing the hard drive.

⚠ CAUTION: To prevent static damage to components inside your computer, discharge static electricity from your body before you touch any of your computer's electronic components. You can do so by touching an unpainted metal surface on the computer chassis.

👉 NOTICE: To avoid damage to the drive, do not set it on a hard surface. Instead, set the drive on a surface, such as a foam pad, that will sufficiently cushion it.

1. If you are replacing a hard drive that contains data you want to keep, back up your files before you begin this procedure.
2. Check the documentation for the drive to verify that it is configured for your computer.
3. Perform an orderly computer shutdown using the operating system menu.
4. Turn off your computer and any attached devices.

👉 NOTICE: To disconnect a network cable, first unplug the cable from your computer, and then unplug it from the network wall jack.

5. Disconnect your computer from the power adapter and devices from their power sources. Also, disconnect any telephone or telecommunication lines from the computer.
6. Press the power button to ground the system board.
7. Remove the computer from the mounting plate (if used).
8. Remove the cable cover, if it is attached.
9. Slide the release button as shown in the illustration.

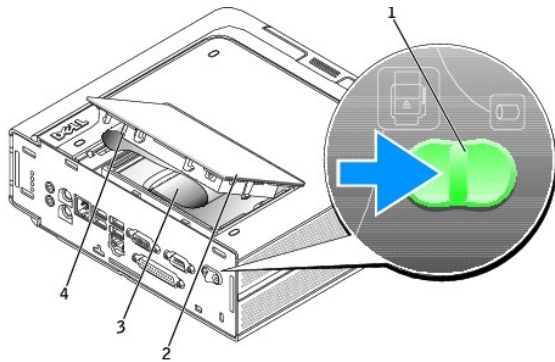

1	release button
2	hard-drive door
3	drive cable
4	drive connector

👉 NOTICE: Before touching anything inside your computer, ground yourself by touching an unpainted metal surface, such as the metal at the back of the computer. While you work, periodically touch an unpainted metal surface to dissipate any static electricity that could harm internal components.

10. Rotate the hard-drive door up and remove the drive cable from the drive connector.
11. Raise the release tab, and slide the drive up and away from the plastic door.

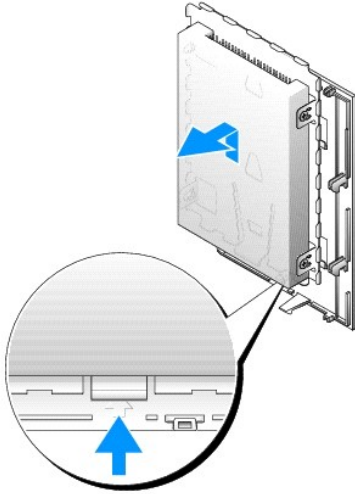

12. If your replacement drive is not attached to a metal sled:
- While holding the drive that you are replacing, remove the screws that hold the drive to the sled.
 - Attach the replacement drive to the sled and replace the screws as shown in the illustration.

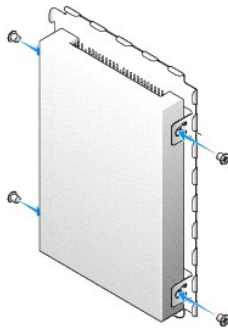

13. Slide the new drive onto the plastic door.

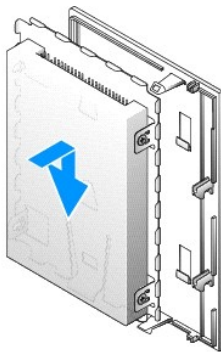

NOTICE: Four pins on the hard drive connector do not have corresponding holes on the cable connector. Use care when attaching the cable so that the drive pins are not bent or broken.

14. Attach the drive cable to the connector on the new drive, being careful not to bend any of the pins.

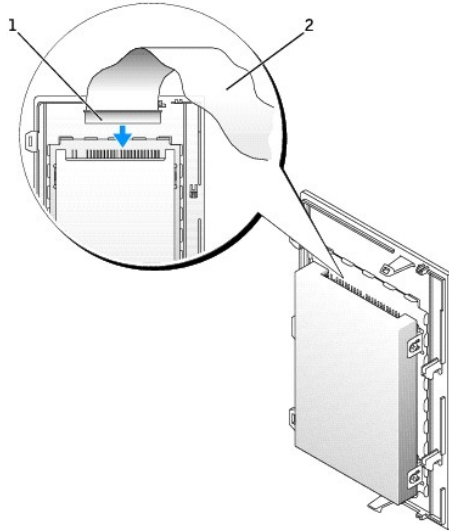

1	drive connector
2	drive cable

15. Slide the drive into the drive bay and lower the hard-drive door to lock into place.
16. Replace the cable cover (if used).
17. Attach the computer to the mounting plate (if used).

➔ **NOTICE:** To connect a network cable, first plug the cable into the network wall jack, and then plug it into the computer.

18. Connect your computer to the power adapter and devices to their electrical outlets, and turn them on.

See the documentation that came with the drive for instructions on installing any software required for drive operation.

19. Reboot the computer.
 20. Partition and logically format your drive before you proceed to the next step.
- For instructions, see the documentation that came with your operating system.

21. Test the hard drive by running the [Dell Diagnostics](#).

22. Install your operating system on the hard drive.

For instructions, see the documentation that came with your operating system.

After you replace the cover, the chassis intrusion detector, if enabled, causes the following message to appear on the screen at the next computer start-up:

ALERT! Cover was previously removed.

23. [Reset the chassis intrusion detector](#) by changing **Chassis Intrusion** to **Enabled** or **Enabled-Silent**.

🔧 **NOTE:** If a setup password has been assigned by someone else, contact your network administrator for information on resetting the chassis intrusion detector.

[Back to Contents Page](#)

[Back to Contents Page](#)

Memory

Dell™ OptiPlex™ SX270 Systems User's Guide

- [Memory Installation Guidelines](#)
 - [Installing Memory](#)
 - [Removing Memory](#)
-

Memory Installation Guidelines

For information on the type of memory supported by your computer, look under "[Memory](#)" in the Technical Specifications section.

- **NOTICE:** Before you install new memory modules, download the most recent BIOS for your computer from the Dell Support website at support.dell.com.

DDR Memory Overview

DDR memory modules should be installed in *pairs of matched memory size, speed, and technology*. If the DDR memory modules are not installed in matched pairs, the computer will continue to operate, but with a slight reduction in performance.

- **NOTE:** Always install DDR memory modules in the order indicated on the system board.

The recommended memory configurations are:

1. A memory module installed in connector DIMM_1
- or
1. A pair of matched memory modules installed in connectors DIMM_1 and DIMM_2

- **NOTICE:** Do not install ECC memory modules.
 1. If you install mixed pairs of PC2700 (DDR 333-MHz) and PC3200 (DDR 400-MHz) memory, the modules function at the slowest speed installed.
 1. Be sure to install a single memory module in DIMM_1, the connector closest to the processor, before you install a module in the other connector.
 1. The actual speed of the SDRAM memory channel will depend on the speed of the processor's front side bus.

- **NOTE:** Memory purchased from Dell is covered under your computer warranty.

- **NOTICE:** If you remove your original memory modules from the computer during a memory upgrade, keep them separate from any new modules that you may have, even if you purchased the new modules from Dell. If possible, *do not* pair an original memory module with a new memory module. Otherwise, your computer may not start properly.
-

Installing Memory

- **CAUTION:** Before working inside your computer, read the safety instructions in "[CAUTION: Safety Instructions](#)".

- **CAUTION:** To prevent static damage to components inside your computer, discharge static electricity from your body before you touch any of your computer's electronic components. You can do so by touching an unpainted metal surface on the computer chassis.

1. Shut down the computer through the **Start** menu.
2. Ensure that your computer and attached devices are turned off. If your computer and attached devices did not automatically turn off when you shut down your computer, turn them off now.

- **NOTICE:** To disconnect a network cable, first unplug the cable from your computer and then unplug it from the network wall jack.

3. Disconnect any telephone or telecommunication lines from the computer.
4. Disconnect your computer and all attached devices from their electrical outlets, and then press the power button to ground the system board.
5. Remove the computer stand, if it is attached.

- **CAUTION:** To guard against electrical shock, always unplug your computer from the electrical outlet before opening the cover.

6. Open the computer cover.

🔗 **NOTICE:** Before touching anything inside your computer, ground yourself by touching an unpainted metal surface, such as the metal at the back of the computer. While you work, periodically touch an unpainted metal surface to dissipate any static electricity that could harm internal components.

7. Press out the securing clip at each end of the memory module connector.

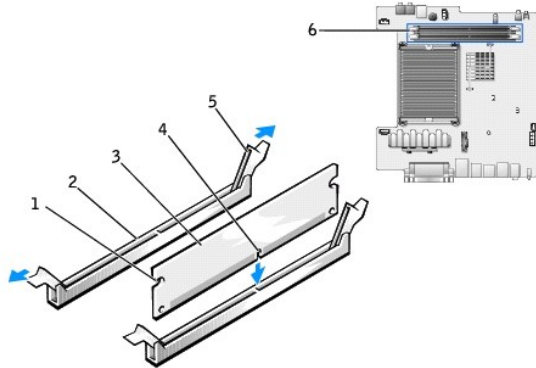

1	cutouts (2)
2	connector
3	memory module
4	notch
5	securing clips (2)
6	memory connectors on system board

8. Align the notch on the bottom of the module with the crossbar in the connector.

🔗 **NOTICE:** To avoid damage to the memory module, press the module straight down into the connector while you apply equal force to each end of the module.

9. Insert the module into the connector until the module snaps into position.

If you insert the module correctly, the securing clips snap into the cutouts at each end of the module.

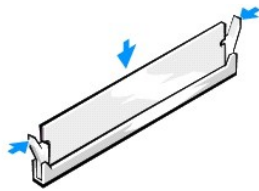

10. Close the computer cover.

11. Attach the computer stand (optional).

🔗 **NOTICE:** To connect a network cable, first plug the cable into the network wall jack and then plug it into the computer.

12. Connect your computer and devices to electrical outlets, and turn them on.

After you open and close the cover, the chassis intrusion detector, if enabled, causes the following message to appear on the screen at the next computer start-up:

ALERT! Cover was previously removed.

13. [Reset the chassis intrusion detector](#) by changing **Chassis Intrusion** to **Enabled** or **Enabled-Silent**.

🔗 **NOTE:** If a setup password has been assigned by someone else, contact your network administrator for information on resetting the chassis intrusion detector.

- The computer detects that the new memory does not match the existing configuration information and generates the following message:

The amount of system memory has changed.
Strike the F1 key to continue, F2 to run the setup utility

- Press <F2> to enter system setup and check the value for **System Memory**.

The computer should have changed the value of **System Memory** to reflect the newly installed memory capacity, speed, and mode (single or dual). Verify that the information is correct. If it is correct, skip to [step 17](#).

- If the memory total is incorrect, turn off and disconnect your computer and devices from their electrical outlets. Open the computer cover and check the installed memory modules to ensure that they are seated properly in their sockets. Then repeat steps [10](#), [11](#), and [12](#).
 - When the **System Memory** total is correct, press <Esc> to exit system setup.
 - Run the [Dell Diagnostics](#) to verify that the memory modules are operating properly.
-

Removing Memory

 **CAUTION:** Before working inside your computer, read the safety instructions in "[CAUTION: Safety Instructions](#)."

 **CAUTION:** To prevent static damage to components inside your computer, discharge static electricity from your body before you touch any of your computer's electronic components. You can do so by touching an unpainted metal surface on the computer chassis.

- Shut down the computer through the **Start** menu.
- Ensure that your computer and attached devices are turned off. If your computer and attached devices did not automatically turn off when you shut down your computer, turn them off now.

 **NOTICE:** To disconnect a network cable, first unplug the cable from your computer and then unplug it from the network wall jack.

- Disconnect any telephone or telecommunication lines from the computer.
- Disconnect your computer and all attached devices from their electrical outlets, and then press the power button to ground the system board.
- Remove the computer stand, if it is attached.

 **CAUTION:** To guard against electrical shock, always unplug your computer from the electrical outlet before opening the cover.

- Open the computer cover.

 **NOTICE:** Before touching anything inside your computer, ground yourself by touching an unpainted metal surface, such as the metal at the back of the computer. While you work, periodically touch an unpainted metal surface to dissipate any static electricity that could harm internal components.

- Press out the securing clip at each end of the memory module connector.
- Grasp the module and pull up.

If the module is difficult to remove, gently ease the module back and forth to remove it from the connector.

[Back to Contents Page](#)

Microprocessor

Dell™ OptiPlex™ SX270 Systems User's Guide

⚠ CAUTION: Before you begin this procedure, follow the steps in "[CAUTION: Safety Instructions.](#)"

⚠ CAUTION: To prevent static damage to components inside your computer, discharge static electricity from your body before you touch any of your computer's electronic components. You can do so by touching an unpainted metal surface on the computer chassis.

1. Shut down the computer through the **Start** menu.
2. Ensure that your computer and attached devices are turned off. If your computer and attached devices did not automatically turn off when you shut down your computer, turn them off now.

➡ NOTICE: To disconnect a network cable, first unplug the cable from your computer and then unplug it from the network wall jack.

3. Disconnect any telephone or telecommunication lines from the computer.
4. Disconnect your computer and all attached devices from their electrical outlets, and then press the power button to ground the system board.
5. Remove the computer from the mounting plate (if used).
6. Remove the cable cover (if used).
7. Remove the stand (if used).

⚠ CAUTION: To guard against electrical shock, always unplug your computer from the electrical outlet before removing the cover.

8. Remove the computer cover.

➡ NOTICE: Before touching anything inside your computer, ground yourself by touching an unpainted metal surface, such as the metal at the back of the computer. While you work, periodically touch an unpainted metal surface to dissipate any static electricity that could harm internal components.

9. Disconnect the two fan power cables from the FAN1 and FAN2 connectors on the system board.
10. Remove the fan shroud by pressing the thumb indentations and sliding the shroud forward, detaching the shroud from the four tabs (see the illustration). Lift the fan shroud up and away from the computer.

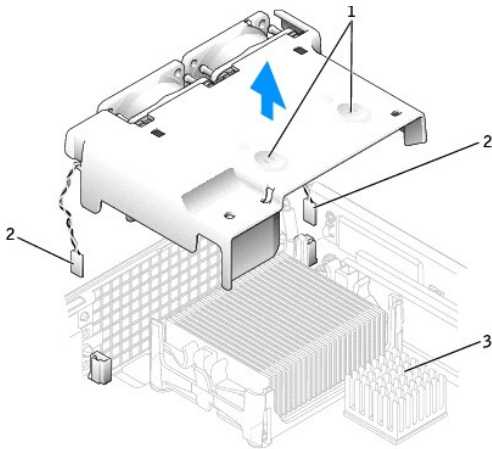

1	thumb indentations
2	fan power cables (2)
3	chip set heat sink (do not remove)

⚠ CAUTION: The heat sink can get extremely hot. Be sure the heat sink has had sufficient time to cool before you touch it.

11. Remove the heat sink.

- a. Remove the two securing brackets, if present, by pressing the tabs together and lifting the brackets up.

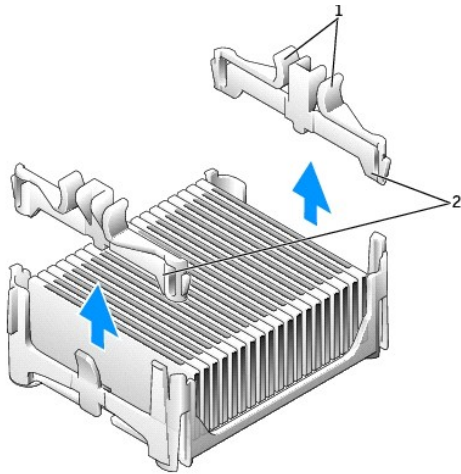

1	tabs (two on each securing bracket)
2	securing brackets (2)

- b. Remove the memory module (see "[Removing Memory](#)") closest to the heat sink.
- c. Press the lever on the retention base until the heat sink is released.

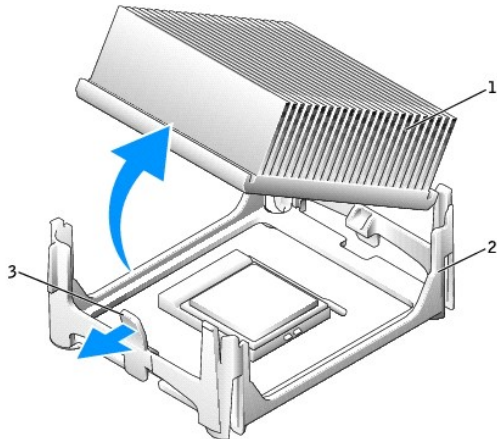

1	heat sink
2	retention base
3	lever

- d. Gently lift the heat sink from the microprocessor.

➡ **NOTICE:** Lay the heat sink down with the thermal material facing upward.

➡ **NOTICE:** Be careful not to bend any of the pins when you remove the microprocessor. Bending the pins can permanently damage the microprocessor.

12. Pull the release lever straight up until the microprocessor is released, and then remove the microprocessor from the socket.

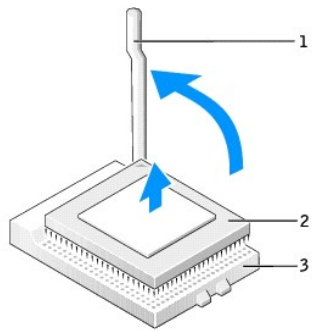

1	release lever
2	microprocessor
3	socket

➡ **NOTICE:** Ground yourself by touching an unpainted metal surface on the back of the computer.

➡ **NOTICE:** Be careful not to bend any of the pins when you unpack the microprocessor. Bending the pins can permanently damage the microprocessor.

13. Unpack the new microprocessor.

If any of the pins on the microprocessor appear to be bent, contact Dell (see "[Getting Help](#)") for instructions on obtaining technical assistance.

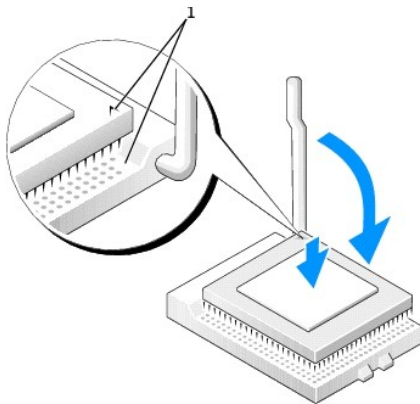

1	pin-1 corners of microprocessor and socket aligned
---	--

➡ **NOTICE:** You must position the microprocessor correctly in the socket to avoid permanent damage to the microprocessor and the computer when you turn on the computer.

14. If the release lever on the socket is not fully extended, move it to that position.

15. Align the pin-1 corners of the microprocessor and socket.

➡ **NOTICE:** When you place the microprocessor in the socket, ensure that all of the pins fit into the corresponding holes on the socket. Be careful not to bend the pins.

16. Set the microprocessor lightly in the socket and ensure that all pins are headed into the correct holes. Do not use force, which could bend the pins if the microprocessor is misaligned. When the microprocessor is positioned correctly, press it with minimal pressure to seat it.

17. When the microprocessor is fully seated in the socket, pivot the release lever back toward the socket until it snaps into place to secure the microprocessor.

➡ **NOTICE:** Ground yourself by touching an unpainted metal surface on the back of the computer.

If you are installing a microprocessor replacement kit from Dell, return the microprocessor to Dell in the same package in which your replacement kit was sent.

18. Place one end of the heat sink under the tab on the retention base on the side opposite the lever (see the illustration). Lower the heat sink onto the microprocessor so that the heat sink fits securely under the tab on the other end of the retention base.

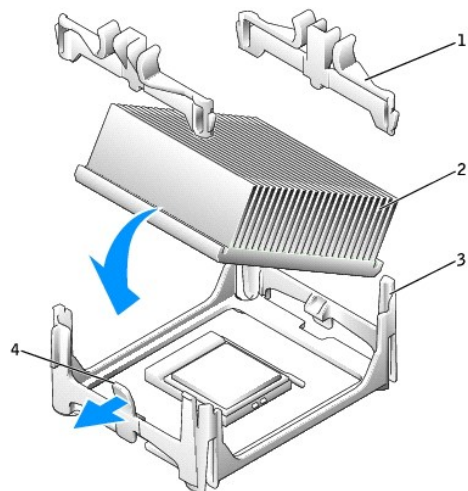

1	securing brackets (2)
2	heat sink
3	retention base
4	lever

19. If you removed securing brackets in [step a](#), replace the securing brackets that you removed.
20. Plug the two fan cables into the FAN1 and FAN2 connectors on the system board.
21. Replace the computer cover.
22. Reattach the stand (if used).
23. Attach the computer to the mounting plate (if used).
24. Replace the cable cover (if used).

➡ **NOTICE:** To connect a network cable, first plug the cable into the network wall jack, and then plug it into the computer.

25. Connect your computer to the adaptor cable and devices to electrical outlets, and turn them on.

After you replace the cover, the chassis intrusion detector, if enabled, causes the following message to appear on the screen at the next computer start-up:

ALERT! Cover was previously removed.

26. [Reset the chassis intrusion detector](#) by changing the **Chassis Intrusion** option to **Enabled** or **Enabled-Silent**.

 **NOTE:** If a setup password has been assigned by someone else, contact your network administrator for information on resetting the chassis intrusion detector.



CAUTION: Safety Instructions

Dell™ OptiPlex™ SX270 Systems User's Guide

- [General](#)
- [When Using Your Computer](#)
- [When Working Inside Your Computer](#)
- [Protecting Against Electrostatic Discharge](#)
- [Ergonomic Computing Habits](#)
- [Battery Disposal](#)

Use the following safety guidelines to help ensure your own personal safety and to help protect your computer and working environment from potential damage.

General

- 1 Do not attempt to service the computer yourself unless you are a trained service technician. Always follow installation instructions closely.
- 1 To help prevent electric shock, plug the computer and device power cables into properly grounded electrical outlets. These cables are equipped with 3-prong plugs to help ensure proper grounding. Do not use adapter plugs or remove the grounding prong from a cable. If you must use an extension cable, use a 3-wire cable with properly grounded plugs.



- 1 To help avoid the potential hazard of electric shock, do not use your computer during an electrical storm.
 - 1 To help avoid the potential hazard of electric shock, do not connect or disconnect any cables or perform maintenance or reconfiguration of this product during an electrical storm.
 - 1 If your computer includes a modem, the cable used with the modem should be manufactured with a minimum wire size of 26 American wire gauge (AWG) and an FCC-compliant RJ-11 modular plug.
 - 1 Before you clean your computer, disconnect the computer from the electrical outlet. Clean your computer with a soft cloth dampened with water. Do not use liquid or aerosol cleaners, which may contain flammable substances.
 - 1 To help avoid possible damage to the system board, wait 5 seconds after turning off the computer before disconnecting a device from the computer.
 - 1 To avoid shorting out your computer when disconnecting a network cable, first unplug the cable from the network adapter on the back of your computer, and then from the network jack. When reconnecting a network cable to your computer, first plug the cable into the network jack, and then into the network adapter.
 - 1 To help protect your computer from sudden, transient increases and decreases in electrical power, use a surge suppressor, line conditioner, or uninterruptible power supply (UPS).
 - 1 Ensure that nothing rests on your computer's cables and that the cables are not located where they can be stepped on or tripped over.
 - 1 Do not push any objects into the openings of your computer. Doing so can cause fire or electric shock by shorting out interior components.
 - 1 Keep your computer away from radiators and heat sources. Also, do not block cooling vents. Avoid placing loose papers underneath your computer; do not place your computer in a closed-in wall unit or on a bed, sofa, or rug.
 - 1 Do not spill food or liquids on your computer. If the computer gets wet, consult "[Repairing a Wet Computer](#)."
 - 1 Do not use your computer during an electrical storm unless the AC adapter cable has been disconnected from the electrical outlet.
 - 1 When you use the AC adapter to run the computer or to charge the battery, place the AC adapter in a ventilated area, such as a desk top or on the floor.
 - 1 The AC adapter may become hot during normal operation of your computer. Use care when handling the adapter during or immediately after operation.
-

When Using Your Computer

As you use your computer, observe the following safe-handling guidelines.



CAUTION: Do not operate your computer with any cover(s) (including computer covers, bezels, filler brackets, front-panel inserts, and so on) removed.

- 1 Your computer is equipped with one of the following:

- A fixed-voltage power supply — Computers with a fixed-voltage power supply do not have a voltage selection switch on the back panel and operate at only one voltage (see the regulatory label on the outside of the computer for its operating voltage).
- An auto-sensing voltage circuit — Computers with an auto-sensing voltage circuit do not have a voltage selection switch on the back panel and automatically detect the correct operating voltage.
- A manual voltage selection switch — Computers with a voltage selection switch on the back panel must be manually set to operate at the correct operating voltage.



Set the switch to the position that most closely matches the voltage used in your location.

- ➔ **NOTICE:** To help avoid damaging a computer with a manual voltage selection switch, set the switch for the voltage that most closely matches the AC power available in your location. For Japan, the voltage selection switch must be set to the 115-V position even though the AC power available in Japan is 100 V. Also, ensure that your monitor and attached devices are electrically rated to operate with the AC power available in your location.
- 1 Before working inside the computer, unplug the computer to help prevent electric shock or system board damage. Certain system board components continue to receive power any time the computer is connected to AC power.

When Working Inside Your Computer

Before you open the computer cover, perform the following steps in the sequence indicated.

- ⚠ **CAUTION:** Do not attempt to service the computer yourself, except as explained in your online Dell™ documentation or in instructions otherwise provided to you by Dell. Always follow installation and service instructions closely.

- ➔ **NOTICE:** To help avoid possible damage to the system board, wait 5 seconds after turning off the computer before removing a component from the system board or disconnecting a device from the computer.

1. Perform an orderly computer shutdown using the operating system menu.
2. Turn off your computer and any devices connected to the computer.
3. Ground yourself by touching an unpainted metal surface on the chassis, such as the metal around the card-slot openings at the back of the computer, before touching anything inside your computer.

While you work, periodically touch an unpainted metal surface on the computer chassis to dissipate any static electricity that might harm internal components.

4. Disconnect your computer and devices, including the monitor, from their electrical outlets. Also, disconnect any telephone or telecommunication lines from the computer.

Doing so reduces the potential for personal injury or shock.

In addition, take note of these safety guidelines when appropriate:

- 1 When you disconnect a cable, pull on its connector or on its strain-relief loop, not on the cable itself. Some cables have a connector with locking tabs; if you are disconnecting this type of cable, press in on the locking tabs before disconnecting the cable. As you pull connectors apart, keep them evenly aligned to avoid bending any connector pins. Also, before you connect a cable, ensure that both connectors are correctly oriented and aligned.
- 1 Handle components and cards with care. Do not touch the components or contacts on a card. Hold a card by its edges or by its metal mounting bracket. Hold a component such as a microprocessor chip by its edges, not by its pins.

- ⚠ **CAUTION:** There is a danger of a new battery exploding if it is incorrectly installed. Replace the battery only with the same or equivalent type recommended by the manufacturer. Do not dispose of the battery along with household waste. Contact your local waste disposal agency for the address of the nearest battery deposit site.

Protecting Against Electrostatic Discharge

Static electricity can harm delicate components inside your computer. To prevent static damage, discharge static electricity from your body before you touch any of your computer's electronic components, such as the microprocessor. You can do so by touching an unpainted metal surface on the computer chassis.

As you continue to work inside the computer, periodically touch an unpainted metal surface to remove any static charge your body may have accumulated.

You can also take the following steps to prevent damage from electrostatic discharge (ESD):

- 1 Do not remove components from their antistatic packing material until you are ready to install the component in your computer. Just before unwrapping the antistatic packaging, discharge static electricity from your body.
- 1 When transporting an electrostatic sensitive component, first place it in an antistatic container or packaging.

1 Handle all electrostatic sensitive components in a static-safe area. If possible, use antistatic floor pads and workbench pads.

Ergonomic Computing Habits

 **CAUTION:** Improper or prolonged keyboard use may result in injury.

 **CAUTION:** Viewing the monitor screen for extended periods of time may result in eye strain.

For comfort and efficiency, observe the ergonomic guidelines in "[Ergonomic Computing Habits](#)" when setting up and using your computer.



Battery Disposal

Your computer uses a lithium coin-cell battery. The lithium coin-cell battery is a long-life battery, and it is very possible that you will never need to replace it. However, should you need to replace it, see "[Battery](#)."

Do not dispose of the battery along with household waste. Contact your local waste disposal agency for the address of the nearest battery deposit site.

[Back to Contents Page](#)

[Back to Contents Page](#)

Solving Problems

Dell™ OptiPlex™ SX270 Systems User's Guide

- [Beep Codes](#)
- [Diagnostic Lights](#)
- [System Lights](#)
- [Battery Problems](#)
- [Drive Problems](#)
- [Repairing a Wet Computer](#)
- [Dropped or Damaged Computer](#)
- [E-Mail, Modem, and Internet Problems](#)
- [Error Messages](#)
- [General Problems](#)
- [Keyboard Problems](#)
- [Memory Problems](#)
- [Mouse Problems](#)
- [Network Problems](#)
- [Power Problems](#)
- [Printer Problems](#)
- [Serial or Parallel Device Problems](#)
- [Sound and Speaker Problems](#)
- [System Board Problems](#)
- [Video and Monitor Problems](#)

Beep Codes

Your computer might emit a series of beeps during start-up if the monitor cannot display errors or problems. This series of beeps, called a beep code, identifies a problem. One possible beep code (code 1-3-1) consists of one beep, a burst of three beeps, and then one beep. This beep code tells you that the computer encountered a memory problem.

If your computer beeps during start-up:









1. Write down the beep code on the [Diagnostics Checklist](#).
2. Run the [Dell Diagnostics](#) to identify a more serious cause.
3. [Contact Dell](#) for technical assistance.





Code	Cause
1-1-2	Microprocessor register failure
1-1-3	NVRAM
1-1-4	ROM BIOS checksum failure
1-2-1	Programmable interval timer
1-2-2	DMA initialization failure
1-2-3	DMA page register read/write failure
1-3	Video Memory Test failure
1-3-1 through 2-4-4	Memory not being properly identified or used
3-1-1	Slave DMA register failure
3-1-2	Master DMA register failure
3-1-3	Master interrupt mask register failure
3-1-4	Slave interrupt mask register failure
3-2-2	Interrupt vector loading failure
3-2-4	Keyboard Controller Test failure
3-3-1	NVRAM power loss
3-3-2	NVRAM configuration
3-3-4	Video Memory Test failure
3-4-1	Screen initialization failure
3-4-2	Screen retrace failure
3-4-3	Search for video ROM failure
4-2-1	No time tick
4-2-2	Shutdown failure
4-2-3	Gate A20 failure
4-2-4	Unexpected interrupt in protected mode
4-3-1	Memory failure above address 0FFFFh
4-3-3	Timer-chip counter 2 failure
4-3-4	Time-of-day clock stopped
4-4-1	Serial or parallel port test failure
4-4-2	Failure to decompress code to shadowed memory
4-4-3	Math-coprocessor test failure
4-4-4	Cache test failure

Diagnostic Lights

To help you troubleshoot a problem, your computer has four lights labeled "A," "B," "C," and "D" on the back panel. The lights can be yellow or green. When the computer starts normally, the patterns or codes on the lights change as the boot process completes. If the POST portion of system boot completes successfully, all four lights display solid green. If the computer malfunctions during the POST process, the pattern displayed on the LEDs may help identify where in the process the computer halted.

⚠ CAUTION: Before you begin any of the procedures in this section, follow the steps in "[CAUTION: Safety Instructions.](#)"

Light Pattern		Problem Description	Suggested Resolution
	off off off off	The computer is in a normal off condition or a possible pre-BIOS failure has occurred.	Verify that the computer is plugged into a working electrical outlet and that you have pressed the power button.
	green yellow yellow yellow	A possible BIOS failure has occurred: the computer is in the recovery mode.	Run the BIOS Recovery utility, wait for recovery completion, and then restart the computer.
	yellow green yellow yellow	A possible microprocessor failure has occurred.	Reinstall the microprocessor and restart the computer.
	green green yellow yellow	Memory modules are detected, but a memory failure has occurred.	<ol style="list-style-type: none"> 1 If you have one memory module installed, reinstall it and restart the computer. 1 If you have two or more memory modules installed, remove the modules, reinstall one module, and then restart the computer. If the computer starts normally, reinstall an additional module. Continue until you have identified a faulty module or reinstalled all modules without error. 1 If available, install properly working memory of the same type into your computer. 1 If the problem persists, contact Dell.
	yellow yellow green yellow	A possible expansion card failure has occurred.	<ol style="list-style-type: none"> 1. Determine if a conflict exists by removing a card (not the video card) and then restarting the computer. 2. If the problem persists, reinstall the card that you removed, remove a different card, and then restart the computer. 3. Repeat this process for each card. If the computer starts normally, troubleshoot the last card removed from the computer for resource conflicts (see "Resolving Software and Hardware Incompatibilities"). 4. Move each card one at a time to a different PCI slot and restart the computer after each move. 5. If the problem persists, contact Dell.
	green yellow green yellow	A possible video card failure has occurred.	<ol style="list-style-type: none"> 1 If the computer has a video card, remove the card, reinstall it, and then restart the computer. 1 If the problem still exists, install a video card that you know works and restart the computer. 1 If the problem persists or the computer has integrated video, contact Dell.
	yellow green green yellow	A possible floppy or hard drive failure has occurred.	Reseat all power and data cables and restart the computer.
	green green green yellow	A possible USB failure has occurred.	Reinstall all USB devices, check cable connections, and then restart the computer.
	yellow yellow	No memory modules are detected.	<ol style="list-style-type: none"> 1 Reinstall all memory modules and restart the computer. 1 To eliminate the possibility of a faulty memory connector, remove all memory modules,

	yellow green		reinstall one memory module (if the computer supports a single module), and then restart the computer. If the computer starts normally, move the memory module to a different connector and restart the computer. Continue until you have identified a faulty connector or reinstalled all modules without error.
	yellow green yellow green	Memory modules are detected, but a memory configuration or compatibility error exists.	<ul style="list-style-type: none"> 1 Ensure that no special memory module/memory connector placement requirements exist. 1 Verify that the memory modules that you are installing are compatible with your computer. 1 If the problem persists, contact Dell.
	yellow green green green	Other failure has occurred.	<ul style="list-style-type: none"> 1 Ensure that the cables are properly connected to the system board from the hard drive, CD drive, and DVD drive. 1 Check the computer message that appears on your monitor screen. 1 If the problem persists, contact Dell.
	green green green green	The computer is in a normal operating condition after POST.	None.

System Lights

Located on the front of the computer, these lights can indicate a computer problem.

Power Light	Problem Description	Suggested Resolution
Solid green	Power is on, and the computer is operating normally.	Normal operating condition. Otherwise, check the back panel diagnostic lights to see if the specific problem is identified. See " Diagnostic Lights ."
Blinking green	The computer is in the suspended state (Microsoft® Windows® 2000 and Windows XP).	Press the power button, move the mouse, or press a key on the keyboard to wake the computer.
Solid yellow	A device on the system board may be faulty or incorrectly installed.	See " Power Problems ." If the problem persists, contact Dell for technical assistance.
Blinking yellow	A power supply or system board failure may have occurred.	See " Power Problems ." If the problem persists, contact Dell for technical assistance.
Solid green and a beep code during POST	A problem was detected while the BIOS was executing.	See " Beep Codes " for instructions on diagnosing the beep code. Also, check the diagnostic lights to see if the specific problem is identified.
Solid green power light and no beep code and no video during POST	The monitor or the graphics card may be faulty or incorrectly installed.	Check the diagnostic lights to see if the specific problem is identified. See " Video and Monitor Problems ."
Solid green power light and no beep code, but the computer locks up during POST	An integrated system board device may be faulty.	Check the diagnostic lights to see if the specific problem is identified. If the problem is not identified, contact Dell for technical assistance.

Battery Problems

Fill out the [Diagnostics Checklist](#) as you complete these checks.

⚠ CAUTION: There is a danger of a new battery exploding if it is incorrectly installed. Replace the battery only with the same or equivalent type recommended by the manufacturer. Discard used batteries according to the manufacturer's instructions.

⚠ CAUTION: Before you begin any of the procedures in this section, follow the steps in "[CAUTION: Safety Instructions](#)."

Replace the battery — If you have to repeatedly reset time and date information after turning on the computer, or if an incorrect time or date displays during start-up, replace the battery. If the battery still does not work properly, [contact Dell](#).

Drive Problems

Fill out the [Diagnostics Checklist](#) as you complete these checks.

Floppy drive problems

Test the drive —

- 1 Insert another disk to eliminate the possibility that the original floppy disk is defective.
- 1 Insert a bootable floppy disk and reboot the computer.

Ensure that the disk is not full or write-protected — Ensure that the disk has available space and that it is not write-protected (locked). See the following illustration.

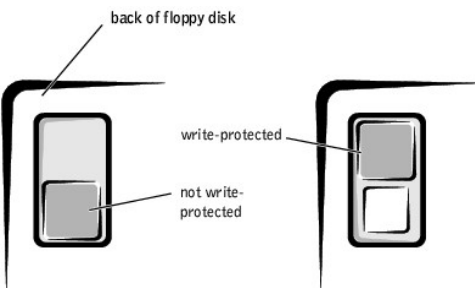

Test the floppy drive light —

MS-DOS®

Insert a floppy disk, type `dir a:` at the DOS prompt, and then press <Enter>.

Microsoft Windows operating systems

Insert a floppy disk, click the **Start** button, click **My Computer**, and then double-click the floppy drive icon.

Run the [Dell Diagnostics](#) — If any of the tests fail, [contact Dell](#).

NOTICE: Do not attempt to clean drive heads with a swab. You may accidentally misalign the heads, which can render the drive inoperable.

Clean the drive — Use a commercially available cleaning kit.

CAUTION: Before you begin any of the procedures in this section, follow the steps in "[CAUTION: Safety Instructions](#)."

[Remove and reinstall the floppy drive](#) —

If the computer displays a drive error message, see "[Floppy drive problems](#)" for an explanation.

CD drive problems

Adjust the Windows volume control — Click the speaker icon in the lower-right corner of your screen.

- 1 Ensure that the volume is turned up by clicking the sidebar and dragging it up.
- 1 Ensure that the sound is not muted by clicking any boxes that are checked.

Test the drive with another CD — Insert another CD to eliminate the possibility that the original CD is defective.

Check the speakers and subwoofer — See "[Sound and Speaker Problems](#)."

Ensure that Windows recognizes the drive — Click the **Start** button and click **My Computer**. If the CD drive is not listed, perform a full scan with your antivirus software to check for and remove viruses. Viruses can sometimes prevent Windows from recognizing the drive.

Clean the disc — Use a commercially available cleaning kit.

Problems writing to a CD-RW drive

Close other programs — The CD-RW drive must receive a steady stream of data when writing. If the stream is interrupted, an error occurs. Try closing all programs before writing to the CD-RW.

DVD drive problems

 **NOTE:** Because of different regions worldwide and different disc formats, not all DVD titles work in all DVD drives.

Test the drive with another DVD — Insert another DVD to eliminate the possibility that the original DVD is defective.

Ensure that Windows recognizes the drive — Click the **Start** button and click **My Computer**. If the DVD drive is not listed, perform a full scan with your antivirus software to check for and remove viruses. Viruses can sometimes prevent Windows from recognizing the drive.

Clean the disc — Use a commercially available cleaning kit.

Check for interrupt request conflicts — See "[Resolving Software and Hardware Incompatibilities](#)."

Hard drive problems

Check the cable connections —

1. Ensure that the DC power cables from the power supply are firmly connected to the connectors on each drive.
2. Verify that the interface cable for each drive is firmly connected to the drive and to the system board.
3. Ensure that the control panel cable is firmly connected to the system board.

If the primary hard drive that contains the operating system does not boot, files in the operating system might be corrupt. For more information, see your operating system documentation.

Run the Hard-Drive Diagnostics Utility — The Dell IDE Hard-Drive Diagnostics is a utility that tests the hard drive to troubleshoot or confirm a hard-drive failure.

1. Turn on your computer (if your computer is already on, restart it).
2. When **F2 = Setup** appears in the upper-right corner of the screen, press <Ctrl><Alt><D>.
3. Follow the instructions on the screen.

Test the hard drive —

Windows XP and Windows 2000 — Run the Check Disk utility:

1. For Windows XP, click the **Start** button and click **My Computer**. For Windows 2000, double-click **My Computer** on the Windows desktop.
2. Click the **Tools** tab.
3. Under **Error-checking**, click **Check Now**.
4. Click **Scan for and attempt recovery of bad sectors**.
5. Click **Start**.

Windows NT — Run the error-checking utility:

1. Click the **Start** button, click **My Computer**, and then select the hard drive that you want to check.
2. Click the right mouse button, click **Properties**, click **Tools**, and then click **Check Now** in the **Error-checking** section.

MS-DOS

Type `scandisk x:` at an MS-DOS prompt, where x is the hard drive letter, and then press <Enter>

Run the Dell Diagnostics — If any of the diagnostics tests fail, [contact Dell](#).

Repairing a Wet Computer

Spills, splashes, and excessive humidity can cause damage to the computer. If an external device, such as a printer, gets wet, contact the manufacturer of the device for instructions.

 **CAUTION:** Before you perform this procedure, follow the steps in "[CAUTION: Safety Instructions](#)."

1. Turn off the computer and devices, disconnect them from their electrical outlets, wait 10 to 20 seconds, and then remove the computer cover.
2. Let the computer dry for at least 24 hours. Make sure that it is thoroughly dry before you proceed.
3. Replace the computer cover, reconnect the computer and devices to their electrical outlets, and turn them on. If the computer has power, proceed to the next step. If the computer does not have power, [contact Dell](#).
4. Run the Dell Diagnostics. If any of the diagnostics tests fail, [contact Dell](#).

Dropped or Damaged Computer

 **CAUTION:** Before you begin any of the procedures in this section, follow the steps in "[CAUTION: Safety Instructions](#)."

Check the card and cable connections —

1. Turn off the computer and devices, disconnect them from their electrical outlets, wait 10 to 20 seconds, and then open the computer cover.
2. Check all card connections in the computer, and reseal any loose cards.
3. Ensure that all cables are properly connected and that all components are properly seated in their connectors and sockets.
4. Close the computer cover, reconnect the computer and devices to electrical outlets, and then turn them on.
5. Run the [Dell Diagnostics](#). If any of the diagnostics tests fail, [contact Dell](#).

E-Mail, Modem, and Internet Problems

Check the telephone line connection — Verify that the telephone line is connected to the jack on the modem. (The jack has either a green label or a connector-shaped icon next to it.) Ensure that you hear a click when you insert the telephone line connector into the modem.

Check the telephone jack — Disconnect the telephone line from the modem and connect it to a telephone. Listen for a dial tone.

Connect the modem directly to the telephone wall jack — If you have other telephone devices sharing the line, such as an answering machine, fax machine, surge protector, or line splitter, then bypass them and use the telephone to connect the modem directly to the telephone wall jack.

Use a different telephone line — If you are using a line that is 3 m (10 ft.) or more in length, try a shorter one.

Run the Modem Helper diagnostics — Click the **Start** button, point to **All Programs**, and then click **Modem Helper**. Follow the instructions on the screen to identify and resolve modem problems. (Modem Helper is not available on all computers.)

Verify that the modem is communicating with Windows® —

1. Click the **Start** button and click **Control Panel**.
2. Click **Printers and Other Hardware**.
3. Click **Phone and Modem Options**.
4. Click the **Modems** tab.
5. Click the COM port for your modem.
6. Click **Properties**, click the **Diagnostics** tab, and then click **Query Modem** to verify that the modem is communicating with Windows.

If all commands receive responses, the modem is operating properly.

Turn off call waiting (catch-phone) — See your telephone directory for instructions on deactivating this feature. Then adjust the dial-up networking connection properties.

1. Click the **Start** button and click **Control Panel**.
2. Click **Printers and Other Hardware**, and then click **Phone and Modem Options**.
3. Click your connection type to highlight it.
4. Click the **Dialing Rules** tab and click **Edit**.
5. Click the **To Disable Call Waiting** box to place a check mark in it.
6. Select the disable code from the drop-down menu (for example, *70).
7. Click **Apply** and click **OK**.

Ensure that you are connected to the Internet — With the Outlook Express e-mail program open, click **File**. If **Work Offline** has a check mark next to it, click the checkmark to remove it and connect to the Internet.

Ensure that you have subscribed to an Internet service provider — Contact an Internet service provider to subscribe.

Contact your Internet service provider — Contact your Internet service provider for assistance.

Error Messages

If the message is not listed, see the documentation for the operating system or the program that was running when the message appeared.

A filename cannot contain any of the following characters: \ / : * ? " < > | — Do not use these characters in filenames.

A required .DLL file was not found — The program that you are trying to open is missing an essential file. To remove and then reinstall the program:

1. Click the **Start** button and click **Control Panel**.
2. Click **Add or Remove Programs**.
3. Select the program you want to remove.
4. Click the **Change or Remove Program** icon.
5. See the program documentation for installation instructions.

Alert! Previous attempts at booting this system have failed at checkpoint [nnnn]. For help in resolving this problem, please note this checkpoint and contact Dell Technical Support — The computer failed to complete the boot routine three consecutive times for the same error. [Contact Dell](#) and report the checkpoint code (nnnn) to the support technician.

Attachment failed to respond — The floppy or hard drive controller cannot send data to the associated drive. See "[Floppy drive problems](#)" or

<p>"Hard drive problems" for troubleshooting suggestions.</p>
<p>Bad command or file name — Ensure that you have spelled the command correctly, have put spaces in the proper place, and have used the correct pathname.</p>
<p>Bad error-correction code (ECC) on disk read — The floppy or hard drive controller detected an uncorrectable read error. See "Floppy drive problems" or "Hard drive problems" for troubleshooting suggestions.</p>
<p>Controller has failed — The hard drive or the associated controller is defective. See "Floppy drive problems" or "Hard drive problems" for troubleshooting suggestions.</p>
<p>Data error — The floppy or hard drive cannot read the data.</p> <ul style="list-style-type: none"> 1 For the Microsoft® Windows® operating system, run the chkdsk utility to check the file structure of the floppy or hard drive. 1 For another operating system, run the appropriate corresponding utility. <p>See your operating system documentation for information on running these utilities.</p>
<p>Decreasing available memory — One or more memory modules might be faulty or improperly seated.</p> <ul style="list-style-type: none"> 1 Reinstall the memory modules and, if necessary, replace them. 1 See "Memory Problems" for additional troubleshooting suggestions.
<p>Diskette drive 0 seek failure — A cable might be loose or the computer configuration information may not match the hardware configuration. See "Floppy drive problems" for troubleshooting suggestions.</p>
<p>Diskette read failure — The floppy disk may be defective or a cable might be loose.</p> <ul style="list-style-type: none"> 1 If the drive access light turns on, try a different disk. 1 See "Floppy drive problems" for troubleshooting suggestions.
<p>Diskette subsystem reset failed — The floppy drive controller might be faulty. Run the Diskette tests in the Dell Diagnostics.</p>
<p>Diskette write protected — The floppy disk is write-protected. Slide the write-protect notch to the open position.</p>
<p>Drive not ready — No floppy disk is in the drive. Put a floppy disk in the drive.</p>
<p>Gate A20 failure — One or more memory modules might be faulty or improperly seated.</p> <ul style="list-style-type: none"> 1 Reinstall the memory modules and, if necessary, replace them. 1 See "Memory Problems" for additional troubleshooting suggestions.
<p>Hard-disk configuration error —</p> <p>Hard-disk controller failure —</p> <p>Hard-disk drive failure —</p> <p>Hard-disk drive failure — The hard drive failed initialization.</p> <ul style="list-style-type: none"> 1 Run the Dell Diagnostics. 1 See "Hard drive problems" for troubleshooting suggestions.
<p>Insert bootable media — The operating system is trying to boot to a nonbootable floppy disk or CD. Insert a bootable floppy disk or CD.</p>
<p>Invalid Configuration Information - Please run SETUP program — The computer configuration information does not match the hardware configuration. Enter system setup and correct the computer configuration information.</p>
<p>Keyboard failure —</p> <p>A cable or connector might be loose, or the keyboard or keyboard/mouse controller might be faulty. See "Keyboard Problems."</p>
<p>Memory address line failure at address, read value expecting value — A memory module might be faulty or improperly seated. Reinstall the memory modules and, if necessary, replace them. See "Memory Problems" for additional troubleshooting suggestions.</p>
<p>Memory allocation error — The software you are attempting to run is conflicting with the operating system, another program, or a utility.</p> <ul style="list-style-type: none"> 1. Turn off the computer, wait 30 seconds, and then restart the computer. 2. Try to run the program again. 3. If the error message appears again, see the software documentation for additional troubleshooting suggestions.
<p>Memory data line failure at address, read value expecting value —</p> <p>Memory double word logic failure at address, read value expecting value —</p> <p>Memory odd/even logic failure at address, read value expecting value —</p> <p>Memory write/read failure at address, read value expecting value —</p> <p>A memory module might be faulty or improperly seated. Reinstall the memory modules and, if necessary, replace them. See "Memory Problems" for additional troubleshooting suggestions.</p>
<p>Memory size in CMOS invalid — The amount of memory recorded in the computer configuration information does not match the memory installed in the computer. Restart the computer. If the error message appears again, contact Dell. See "Memory Problems" for additional</p>

troubleshooting suggestions.
Memory tests terminated by keystroke — A keystroke interrupted the memory test. Restart the computer to rerun the test.
No boot device available — The computer cannot find the floppy disk or hard drive. <ul style="list-style-type: none"> 1 If the floppy drive is your boot device, ensure that a bootable floppy disk is in the drive. 1 If the hard drive is your boot device, ensure that the drive is installed, properly seated, and partitioned as a boot device. 1 Enter system setup and ensure that the boot sequence information is correct.
No boot sector on hard-disk drive — The computer configuration information in system setup might be incorrect. Enter system setup and ensure that the computer configuration information for the hard drive is correct. The operating system might have been corrupted. Reinstall the operating system. See your operating system documentation for reinstallation information.
No timer tick interrupt — A chip on the system board might be malfunctioning. Run the Dell Diagnostics .
Non-system disk or disk error — The floppy disk in drive A does not have a bootable operating system installed on it. Either replace the floppy disk with one that has a bootable operating system, or remove the floppy disk from drive A and restart the computer.
Not a boot diskette — The operating system is trying to boot to a floppy disk that does not have a bootable operating system installed on it. Insert a bootable floppy disk.
Not enough memory or resources. Close some programs and try again — You have too many programs open. Close all windows and open the program that you want to use. In some cases, you might have to restart your computer to restore computer resources. If so, run the program that you want to use first.
Operating system not found — Contact Dell .
Plug and Play Configuration Error — The computer encountered a problem while trying to configure one or more cards. <ol style="list-style-type: none"> 1. Turn your computer off, unplug it from the electrical outlet, and then remove all but one of the cards. 2. Plug in your computer and reboot it. 3. If the message reappears, the installed card might be malfunctioning. If the message does not reappear, turn off the computer and reinsert one of the other cards. 4. Repeat this process until you identify which card is malfunctioning.
Read fault — The operating system cannot read from the floppy or hard drive, the computer could not find a particular sector on the disk, or the requested sector is defective. See " Floppy drive problems " or " Hard drive problems " for troubleshooting suggestions.
Requested sector not found — The operating system cannot read from the floppy or hard drive, the computer could not find a particular sector on the disk, or the requested sector is defective. See " Floppy drive problems " or " Hard drive problems " for troubleshooting suggestions.
Reset failed — The disk reset operation failed. See " Floppy drive problems " or " Hard drive problems " for troubleshooting suggestions.
Sector not found — The operating system cannot locate a sector on the floppy or hard drive. <ul style="list-style-type: none"> 1 Run the Windows error-checking utility to check the file structure on the floppy disk or hard drive. See Windows Help for instructions. 1 If a large number of sectors are defective, back up the data (if possible), and then reformat the floppy disk or hard drive.
Seek error — The operating system cannot find a specific track on the floppy disk or hard drive. See " Floppy drive problems " or " Hard drive problems " for troubleshooting suggestions.
Shutdown failure — A chip on the system board might be malfunctioning. Run the Dell Diagnostics .
The file being copied is too large for the destination drive — The file that you are trying to copy is too large to fit on the disk. Try copying the file to a blank disk or using a larger-capacity disk.
Time-of-day clock stopped — The battery might be dead. Enter system setup and correct the date or time. If the problem persists, contact Dell . See " Battery Problems " for additional troubleshooting suggestions.
Time-of-day not set—please run the System Setup program — The time or date stored in system setup does not match the computer clock. Enter system setup and correct the Date and Time options.
Timer chip counter 2 failed — A chip on the system board might be malfunctioning. Run the Dell Diagnostics .
Unexpected interrupt in protected mode — The keyboard controller might be malfunctioning, or a memory module might be loose. Run the Dell Diagnostics .
WARNING: Dell's Disk Monitoring System has detected that drive [O/1] on the [primary/secondary] EIDE controller is operating outside of normal specifications. It is advisable to immediately back up your data and replace your hard drive by calling your support desk or Dell — During initial start-up, the drive detected possible error conditions. <ul style="list-style-type: none"> 1 When your computer finishes booting, immediately back up your data and replace your hard drive. 1 If no replacement drive is immediately available and the drive is not the only bootable drive, enter system setup and change the appropriate drive setting to None. Then remove the drive from the computer.
Write fault — The operating system cannot write to the floppy or hard drive. See " Floppy drive problems " or " Hard drive problems " for troubleshooting suggestions.
Write fault on selected drive — The operating system cannot write to the floppy or hard drive. See " Floppy drive problems " or " Hard drive problems " for troubleshooting suggestions.
x:\ is not accessible. The device is not ready — The floppy drive cannot read the disk. Insert a floppy disk into the drive and try again.

General Problems

The computer stops responding

Turn the computer off — If your computer locks up and you are unable to get a response by pressing a key on your keyboard or moving your mouse, press and hold the power button for at least 8 to 10 seconds until the computer turns off. Then press the power button again

to turn on the computer. You might lose data if you are unable to perform an operating system shutdown.

A program stops responding

End the program —

Windows® XP, Windows 2000, Windows NT®

1. Press <Ctrl><Shift><Esc> simultaneously.
2. Click **Applications**.
3. Click the program that is no longer responding.
4. Click **End Task**.

Windows 98

1. Press <Ctrl><Alt><Delete> simultaneously.
2. Click the program that is no longer responding.
3. Click **End Task**.

A program crashes repeatedly

 **NOTE:** Software usually includes installation instructions in its documentation or on a floppy disk or CD.

Check the software documentation — Many software manufacturers maintain websites with information that may help you solve the problem. Ensure that you properly installed and configured the program. If necessary, uninstall and then reinstall the program.

A solid blue screen appears

Turn the computer off — If the computer does not respond to a keystroke or a proper shutdown, press the power button for at least 8 to 10 seconds until the computer turns off. Press the power button again to restart the computer. The chkdisk program automatically runs during the start-up process. Follow the instructions on the screen.

Other software problems

Check the software documentation or contact the software manufacturer for troubleshooting information

Back up your files immediately — If your computer has a CD-RW drive or a zip drive installed, see the drive's documentation for instructions.

Ensure that you have not made an error while entering data — See the program documentation to ensure that the values or characters you are entering are valid.

Check for viruses — Use a virus-scanning program to check the hard drive, floppy disks, or CDs.

Restart the computer — Save and close any open files, exit any open programs, and then shut down your computer through the **Start** menu instead of by pressing the power button. Otherwise, you may lose data.

Check for compatibility —

1. Ensure that the program is compatible with the operating system installed on your computer and that your computer meets the minimum hardware requirements needed to run the software. See the software documentation for information.
1. If necessary, uninstall and then reinstall the program.

Ensure that you properly installed and configured the program — See the software documentation for information. If necessary, uninstall and then reinstall the program.

Run the [Dell Diagnostics](#) — If all tests run successfully, the error condition is related to a software problem.

Check for device driver conflicts —

1. Verify that the program's device drivers do not conflict with certain programs.
1. Call the software manufacturer for technical assistance.

Other technical problems

Go to the Dell Support website —

Go to support.dell.com for help with general usage, installation, and troubleshooting questions. The support website offers several different tools to help you, such as Dell Forum—a chat room where you can communicate with other Dell customers about their computers and gain

access to technical support through e-mail.

Call Dell — If you cannot solve your problem using the Dell Support website or e-mail service, [call Dell](#) for technical assistance.

General hardware problems

If your computer exhibits one or more of the following symptoms, a device conflict may exist:

- 1 Your computer locks up, particularly while using a specific device.
- 1 A recently added device does not work.
- 1 Memory parity errors occur on parity-enabled computers.
- 1 A sound card emits noise or demonstrates other problems.
- 1 Unintelligible characters print from the printer.
- 1 The mouse pointer does not move or "stutters" when it moves.
- 1 Messages appear stating that the computer is not operating at maximum performance.
- 1 Errors occur and programs crash for no apparent reason.
- 1 Nothing displays on the monitor.

Remove any recently added hardware to see if it resolves the conflict — If removing the hardware resolves the conflict, see the hardware documentation for configuration and troubleshooting instructions. If the problem persists, contact the hardware manufacturer for technical assistance.

Check your operating system documentation for additional troubleshooting information

Check for interrupt request conflicts — See "[Resolving Software and Hardware Incompatibilities](#)."

Keyboard Problems

Fill out the [Diagnostics Checklist](#) as you complete these checks.

Restart the computer —

- 1 If the mouse is functioning, shut down the computer through the **Start** menu. After the computer shuts down, press the power button to restart the computer.
- 1 If the computer does not respond to a keystroke or the mouse, press the power button for at least 8 to 10 seconds until the computer turns off. Press the power button again to restart the computer.

Check the keyboard cable —

- 1 Ensure that the keyboard cable is firmly connected to the computer.
- 1 Check the cable connector for bent or broken pins and for damaged or frayed cables. Straighten bent pins.
- 1 Remove keyboard extension cables and connect the keyboard directly to the computer.

Test the keyboard — Connect a properly working keyboard to the computer, and try using the keyboard. If the new keyboard works, the original keyboard is faulty.

Check the keyboard switch setting — Switch settings are on the bottom of the keyboard, sometimes behind a panel. Ensure that the switch is set to **PS/2**, **Enhanced XT/AT**, or **PC/AT**. See the keyboard documentation for recommended settings.

Run the Dell Diagnostics — If any of the diagnostics tests fail, [contact Dell](#).

Check for interrupt request conflicts — See "[Resolving Software and Hardware Incompatibilities](#)."

Memory Problems

 **CAUTION:** Before you begin any of the procedures in this section, follow the steps in "[CAUTION: Safety Instructions](#)."

If you receive an insufficient memory message —

- 1 Save and close any open files and exit any open programs you are not using to see if that resolves the problem.
- 1 Confirm that the computer has sufficient memory to run your programs. See the software documentation for minimum memory requirements. If necessary, [install](#) additional memory.
- 1 Reseat the memory modules to ensure that your computer is successfully communicating with the memory.
- 1 Restart the computer.
- 1 Run the [Dell Diagnostics](#). If any of the diagnostics tests fail, [contact Dell](#).

If you experience other memory problems —

- 1 Reseat the memory modules to ensure that your computer is successfully communicating with the memory.
- 1 Restart the computer.
- 1 Run the [Dell Diagnostics](#). If any of the diagnostics tests fail, [contact Dell](#).

Mouse Problems

Fill out the [Diagnostics Checklist](#) as you complete these checks.

Restart the computer —

1. Simultaneously press <Ctrl><Esc> to display the **Start** menu.
2. Type **u**, press the keyboard arrow keys to highlight **Shut down** or **Turn Off**, and then press <Enter>.
3. After the computer turns off, press the power button to restart the computer.

Check the mouse cable —

1. Check the cable connector for bent or broken pins and for damaged or frayed cables. Straighten bent pins.
1. Ensure that the cable is firmly connected to the computer.

Test the mouse — Connect a properly working mouse to the computer, and try using the mouse. If the new mouse works, the original mouse was faulty.

Check the mouse settings —

Windows® XP

1. Click the **Start** button, click **Control Panel**, and then click **Printers and Other Hardware**.
2. Click **Mouse**.
3. Try adjusting the settings.

Windows 2000, Windows NT®, and Windows 98

1. Click the **Start** button, point to **Settings**, and then click **Control Panel**.
2. Double-click the **Mouse** icon.
3. Try adjusting the settings.

If you are using a PS/2 mouse

1. Enter [system setup](#) and ensure that **Mouse Port** under the **Integrated Devices** option is set to **On**.
2. Exit system setup and restart the computer.

Reinstall the mouse driver — See "[Reinstalling Drivers and Utilities](#)."

Run the Dell Diagnostics — If any of the diagnostics tests fail, [contact Dell](#).

Check for interrupt request conflicts — See "[Resolving Software and Hardware Incompatibilities](#)."

Network Problems

Check the network cable connector — Ensure that the network cable is firmly inserted into both the network connector on the back of the computer and the network jack.

Check the network lights on the back of the computer —

If the network adapter lights are blank (off) it indicates that a physical connection to the network cannot be detected or that the integrated network adapter is disabled in System Setup.

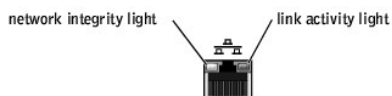

Restart the computer and try to log on to the network again

Check your network settings — Contact your network administrator or the person who set up your network to verify that your network settings are correct and that the network is functioning.

Check for interrupt request conflicts — See "[Resolving Software and Hardware Incompatibilities](#)."

Power Problems

CAUTION: Before you begin any of the procedures in this section, follow the steps in "[CAUTION: Safety Instructions](#)."

Fill out the [Diagnostics Checklist](#) as you complete these checks.

Adjust the Power Properties — Your computer may be in standby or hibernate mode. For information on power conservation modes, see your operating system documentation.
If the power light is green and the computer is not responding — See " Diagnostic Lights ."
If the power light is blinking green — The computer is in standby mode. Press a key on the keyboard or move the mouse to resume normal operation.
If the power light is off — The computer is either turned off or is not receiving power. <ul style="list-style-type: none">1 Reseat the power cable into both the power connector on the back of the computer and the electrical outlet.1 If the computer is plugged into a power strip, ensure that the power strip is plugged into an electrical outlet and that the power strip is turned on.1 Ensure that the electrical outlet is working by testing it with another device, such as a lamp.1 Bypass power protection devices, power strips, and power extension cables to verify that the computer turns on.1 Ensure that the main power cable is securely connected to the system board.1 Ensure that the front panel cable is securely connected to the system board.1 If the problem persists, contact Dell.
If the power light is amber and green — The computer is receiving electrical power, but an internal power problem might exist. <ul style="list-style-type: none">1 Ensure that the voltage selection switch is set to match the AC power at your location.1 If the problem persists, contact Dell.
If the power light is steady amber — The computer is receiving electrical power, but an internal power problem might exist; contact Dell .
If the power light is blinking amber — A device might be malfunctioning or incorrectly installed. <ul style="list-style-type: none">1 Remove and then reinstall the memory modules.1 Remove and then reinstall any card.1 Remove and then reinstall the video card, if applicable.1 If the problem persists, contact Dell.
Eliminate interference — Electrical appliances on the same circuit or operating near the computer can cause interference. Other causes of interference are: <ul style="list-style-type: none">1 Power extension cables1 Keyboard and mouse extension cables1 Too many devices on a power strip1 Multiple power strips connected to the same electrical outlet

Printer Problems

 **NOTE:** Dell does not cover the printer's warranty. If you need technical assistance for your printer, call the printer's manufacturer. See the printer documentation for the correct phone number.

Check the printer documentation — See the printer documentation for setup and troubleshooting information.
Ensure that the printer is turned on — See the printer documentation for power button information.
Verify the printer cable connections — <ul style="list-style-type: none">1 See the printer documentation for cable connection information.1 Ensure that the printer cables are securely connected to the printer and the computer.
Test the electrical outlet — Ensure that the electrical outlet is working by testing it with another device, such as a lamp.
Verify that the printer is recognized by Windows® — <p><i>Windows XP</i></p> <ol style="list-style-type: none">1. Click the Start button.2. Click Control Panel.3. Click Printers and Other Hardware.4. Click View installed printers or fax printers. <p>If the printer is listed, right-click the printer icon.</p> <ol style="list-style-type: none">5. Click Properties, and then select the Ports tab. For a parallel printer, ensure that the Print to the following port(s): setting is LPT1 (Printer Port). For a USB printer, ensure that the Print to the following port(s): setting is USB. <p><i>Windows 2000 and Windows NT®</i></p> <ol style="list-style-type: none">1. Click the Start button, point to Settings, and then click Printers. <p>If the printer is listed, right-click the printer icon.</p> <ol style="list-style-type: none">2. Click Properties, and then select the Ports tab. For a parallel printer, ensure that the Print to the following port(s): setting is LPT1 (Printer Port). For a USB printer, ensure that the Print to the following port(s): setting is USB.

Windows 98

1. Click the **Start** button, point to **Settings**, and then click **Printers**.

If the printer is listed, right-click the printer icon.
2. Click **Properties**, and then select the **Details** tab. For a parallel printer, ensure that the **Print to the following port(s)**: setting is **LPT1 (Printer Port)**. For a USB printer, ensure that the **Print to the following port(s)**: setting is **USB**.

Reinstall the printer driver — See "[Reinstalling Drivers and Utilities](#)."

Serial or Parallel Device Problems

Fill out the [Diagnostics Checklist](#) as you complete these checks.

 **NOTE:** If you are having a problem with a printer, see "[Printer Problems](#)."

Check the documentation for the device — See the device's documentation for troubleshooting procedures.

Ensure that the device is turned on — Firmly press the device's power button.

Check the device cable connections — Check the connector for bent or broken pins. (It is normal for most device cable connectors to have missing pins.) Ensure that the device cable is firmly connected to the computer.

Test the device cable — Swap the device's cable with a cable that works properly.

Test the electrical outlet — Ensure that the electrical outlet is working by testing it with another device, such as a lamp.

Eliminate interference — Relocate any electrical appliances on the same circuit or operating near the computer that might cause interference. Remove these other possible causes of interference:

- 1 Power extension cables
- 1 Keyboard and mouse extension cables
- 1 Too many devices on a power strip
- 1 Multiple power strips connected to the same electrical outlet

Check the option setting — See the device's documentation for the recommended settings. Then enter [system setup](#) and go to the **Integrated Devices** option settings. Ensure that the **Serial Port** setting (for a serial device) or the **Parallel Port** setting (for a parallel device) matches the recommended settings.

Check the software documentation — If the problem occurs with particular software, see the software documentation for the recommended serial or parallel port settings. Ensure that the port settings match the recommended settings.

Run the [Dell Diagnostics](#) — If the tests do not complete, [contact Dell](#).

Test the device — Swap the device with a comparable device that works properly.

Sound and Speaker Problems

Fill out the [Diagnostics Checklist](#) as you complete these checks.

No sound from speakers

 **NOTE:** The volume control in some MP3 players overrides the Windows® volume setting. If you have been listening to MP3 songs, ensure that you did not turn the player volume down or off.

Check the speaker cable connections — Ensure that the speakers are connected as shown on the setup diagram supplied with the speakers.

Ensure that the subwoofer and the speakers are turned on — See the setup diagram supplied with the speakers. If your speakers have volume controls, adjust the volume, bass, or treble to eliminate distortion.

Adjust the Windows volume control — Click or double-click the speaker icon in the lower-right corner of your screen. Ensure that the volume is turned up and that the sound is not muted.

Disconnect headphones from the headphone connector — Sound from the speakers is automatically disabled when headphones are connected to the computer's front-panel headphone connector.

Test the electrical outlet — Ensure that the electrical outlet is working by testing it with another device, such as a lamp.

Eliminate possible interference — Turn off nearby fans, fluorescent lights, or halogen lamps to check for interference.

Run the speaker diagnostics — Some speaker systems have self-diagnostics. See the speaker documentation for diagnostics instructions.

Reinstall the audio (sound) driver — See "[Reinstalling Drivers and Utilities](#)."

Check the device option setting — Enter [system setup](#) and ensure that **Sound** under the **Integrated Devices** option is set to **On**. Exit system setup and reboot the computer.

Run the [Dell Diagnostics](#) —

- 1 If the tests complete successfully, the controller is functioning properly.
- 1 If the problem persists, or if the tests do not complete successfully, [contact Dell](#).

Check for interrupt request conflicts — See "[Resolving Software and Hardware Incompatibilities](#)."

No sound from headphones

Check the headphone cable connection — Ensure that the headphone cable is securely inserted into the headphone connector.

Adjust the Windows volume control — Click or double-click the speaker icon in the lower-right corner of your screen. Ensure that the volume is turned up and that the sound is not muted.

System Board Problems

Fill out the [Diagnostics Checklist](#) as you complete the following checks.

Perform all checks in "[Keyboard Problems](#)."

 **CAUTION:** Before you begin any of the procedures in this section, follow the steps in "[CAUTION: Safety Instructions](#)."

Reinstall the battery —

1. Turn off the computer and devices, disconnect them from their electrical outlets, wait 10 to 20 seconds, and then open the computer cover.
2. Remove the battery, wait 5 minutes, and then reinstall the battery.
3. Close the computer cover, reconnect the computer and devices to electrical outlets, and then turn them on.

If the problem still exists, [contact Dell](#).

 **CAUTION:** Before you begin any of the procedures in this section, follow the steps in "[CAUTION: Safety Instructions](#)."

Replace the Memory Modules —

1. Turn off the computer and devices, disconnect them from their electrical outlets, wait 10 to 20 seconds, and then open the computer cover.
2. Rotate the power supply away from the system board.
3. Replace the memory module(s).
4. Close the computer cover, reconnect the computer and devices to electrical outlets, and then turn them on.
5. If the RAM count displayed does not correctly match the actual amount of memory installed in the computer, [contact Dell](#).

Video and Monitor Problems

Fill out the [Diagnostics Checklist](#) as you complete these checks.

If the screen is blank

 **NOTE:** See the monitor documentation for troubleshooting procedures.

Check the monitor power light — If the power light is off, firmly press the button to ensure that the monitor is turned on. If the power light is lit or blinking, the monitor has power. If the power light is blinking, press a key on the keyboard or move the mouse.

Check the monitor cable connection — Check the connector for bent or broken pins. (It is normal for monitor cable connectors to have missing pins.)

Check the RGB/DVI video input switch found on some Digital Flat Panel displays — Check that the desired video input is selected.

Test the electrical outlet — Ensure that the electrical outlet is working by testing it with another device, such as a lamp.

Swap the power cables — Swap the computer and monitor power cables to determine if the power cable is defective.

Test the video extension cable (if used) — If you are using a video extension cable and removing the cable solves the problem, the cable is defective.

Test another monitor — If another monitor is available, connect it to the computer.

Check the diagnostic lights — See "[Diagnostic Lights](#)."

Run the [Dell Diagnostics](#) — If any tests fail, [contact Dell](#).

If the screen is difficult to read

Check the monitor settings — See the monitor documentation for instructions on adjusting the contrast and brightness, demagnetizing (degaussing) the monitor, and running the monitor self-test.

Move the subwoofer away from the monitor — If your speaker system includes a subwoofer, ensure that the subwoofer is at least 60 cm (2 ft) away from the monitor.

Move the monitor away from external power sources — Fans, fluorescent lights, halogen lamps, and other electrical devices can cause the screen image to appear "shaky." Turn off nearby devices to check for interference.

Adjust the Windows® display settings —

Windows XP

1. Click the **Start** button and click **Control Panel**.
2. Click **Appearance and Themes**.
3. Click **Display** and click the **Settings** tab.
4. Try different settings for **Screen resolution** and **Color quality**.

Windows 98, 2000, and Windows NT®

1. Click the **Start** button, point to **Settings**, and then click **Control Panel**.
2. Double-click the **Display** icon and click the **Settings** tab.
3. Try different settings for **Screen area** or **Desktop area**.

Restore the recommended settings — Restore the original resolution and refresh rate settings.

[Back to Contents Page](#)

[Back to Contents Page](#)

Technical Specifications

Dell™ OptiPlex™ SX270 Systems User's Guide

- [Microprocessor](#)
- [Memory](#)
- [Computer Information](#)
- [Audio](#)
- [Video](#)
- [Expansion Bus](#)
- [Drives](#)
- [Ports](#)
- [Key Combinations](#)
- [Controls and Lights](#)
- [Power](#)
- [Physical](#)
- [Environmental](#)

Microprocessor	
Microprocessor type	Intel® Pentium® 4 and Celeron® microprocessors. Design provides for future processor upgrades. Supported processor upgrades are available from Dell.
Level 1 (L1) cache	8 KB
Level 2 (L2) cache	128-KB or 512-KB (depending on your computer configuration) pipelined-burst, eight-way set associative, write-back SRAM
Memory	
Architecture	333- and 400-MHz DDR SDRAM
Dual in-line memory module (DIMM) sockets	two (non-ECC only)
DIMM capacities	128, 256, 512 MB, and 1 GB
Minimum RAM	128 MB
Maximum RAM	2 GB
BIOS address	F0000h
Computer Information	
Computer chip set	Intel 865G
Data bus width	64 bits
Address bus width	32 bits
Interrupts	23
Computer BIOS	4-Mb flash chip
System bus speed	800-, 533-, or 400-MHz quad-data rate; 200-, 133-, or 100-MHz clock (matches external bus speed)
Network interface controller	Gigabit integrated network interface with ASF 1.0 support as defined by DMTF Capable of 10/100/1000 communication
Audio	
Audio type	AC97, Sound Blaster emulation; optional internal speaker
Audio controller	Integrated AC97 Codec
Stereo conversion	16-bit analog-to-digital; 20-bit digital-to-analog
Interfaces:	
Internal	PCI bus/AC97
External	stereo line-in minijack and line-out minijack on the rear I/O panel; headphone and microphone connectors on the front panel
Video	
865G embedded graphics	
Expansion Bus	
Bus type	USB 2.0
Memory module connector size	DDR — 184 pins
Drives	
Externally accessible bay	one bay for Dell C-module portable devices
Internally accessible bay	one bay for a parallel ATA100 2.5-inch hard drive
Ports	
Externally accessible:	
Serial (data terminal equipment [DTE])	one 9-pin connector; 16550-compatible on the back I/O panel
Parallel	one 25-hole connector (bidirectional) on the back I/O panel

Video	DVI-I connector on the back I/O panel
Integrated network adapter	RJ45 connector on the back I/O panel; 10/100/1000
PS/2-style keyboard	6-pin mini-DIN on the back I/O panel
PS/2-compatible mouse	6-pin mini-DIN on the back I/O panel
USB	four USB 2.0-compliant connectors on the back I/O panel; two on the front panel
Internally accessible:	
Primary IDE hard drive	44-pin connector
Fans	two 4-pin connectors
Key Combinations	
<Ctrl><Alt>	restarts (reboots) the computer
<Ctrl><Alt><\>	toggles microprocessor speeds on 101-key keyboard (in MS-DOS® real mode only)
<Ctrl><Alt><#>	toggles microprocessor speeds on 102-key keyboard (in MS-DOS real mode only)
<F2> or <Ctrl><Alt><Enter>	starts embedded system setup (during start-up only)
<F3>	automatically starts the computer from the network environment specified by the remote boot environment (PXE) rather than from one of the devices in the system setup Boot Sequence option (during start-up only)
<F12> or <Ctrl><Alt><F8>	displays a boot device menu that allows the user to enter a device for a single boot (during start-up only) as well as options to run hard-drive and system diagnostics
<Ctrl><Alt><F10>	launches the utility partition (if installed) during computer start-up
Controls and Lights	
Power control	push button
Power lights	green light on power button—blinking green in sleep state; solid green for power-on state amber light—blinking amber indicates a problem with an installed device; solid amber indicates an internal power problem (see "Power Problems")
Hard-drive access light	green light
Link integrity light (on integrated network adapter)	green light for 10-Mb operation; orange light for 100-Mb operation; yellow light for a 1000-Mb (1-Gb) operation
Activity light (on integrated network adapter)	yellow blinking light
Diagnostic lights	four yellow and/or green lights on back panel
Standby power light	12V_PWR on the system board
Power	
External DC power adapter:	
Wattage	150 W
Heat dissipation	455 BTU/hr (average)
Voltage	90 to 135 V at 60 Hz; 180 to 265 V at 50 Hz
Backup battery	3-V CR2032 lithium coin cell
Physical	
Vertical orientation width, depth, and height (without stand or cable cover)	3.4 inches (8.5 cm), 9.7 inches (24.2 cm), 9.9 inches (24.7 cm)
Vertical orientation width, depth, and height (with stand)	3.4 inches (8.5 cm), 9.7 inches (24.2 cm), 10.9 inches (27.2 cm)
Vertical orientation width, depth, and height (with stand and cable cover)	3.4 inches (8.5 cm), 12.1 inches (30.2 cm), 10.9 inches (27.2 cm)
Horizontal orientation width, depth, and height (without stand or cable cover)	9.9 inches (24.7 cm), 9.7 inches (24.2 cm), 3.4 inches (8.5 cm)
Weight (without stand or cable cover)	7.2 lbs (3.3 kg)
Weight (with stand and cable cover)	8 lbs (3.6 kg)
Environmental	
Temperature:	
Operating	10° to 30°C (50° to 86°F)
Storage	-40° to 65°C (-40° to 149°F)
Relative humidity	20% to 80% (noncondensing)
Maximum vibration:	
Operating	desktop or vertical hanging orientation: 0.25 gravities (G) at 3 to 200 Hz at 0.5 octave/min; horizontal orientation: 0.25 G at 20 to 200 Hz at 0.5 octave/min

Storage	0.5 G at 3 to 200 Hz at 1 octave/min
Maximum shock:	
Operating	bottom half-sine pulse with a change in velocity of 20 inches/sec (50.8 cm/sec)
Storage	27-G faired square wave with a velocity change of 200 inches/sec (508 cm/sec)
Altitude:	
Operating	-16 to 3048 m (-50 to 10,000 ft)
Storage	-16 to 10,600 m (-50 to 35,000 ft)

[Back to Contents Page](#)

System Board Components

Dell™ OptiPlex™ SX270 Systems User's Guide

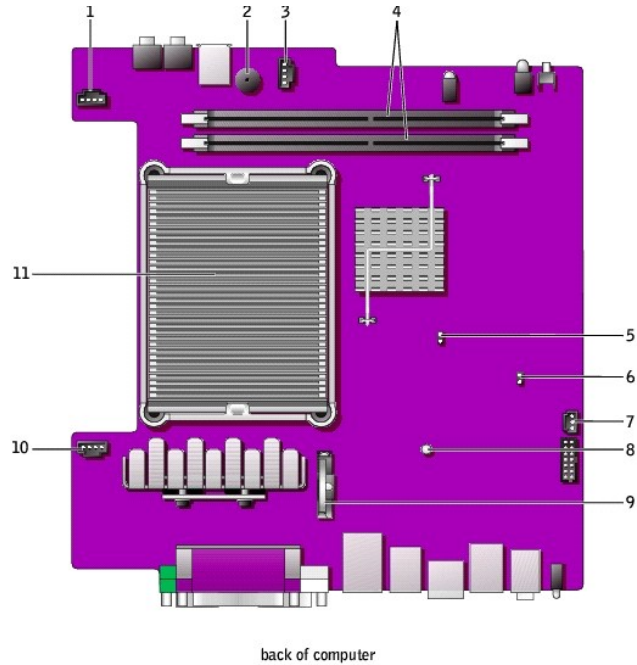

1	fan shroud power connector (FAN2)
2	system board speaker (SPEAKER)
3	speaker connector (SPEAKER)
4	memory modules (DIMM_A and DIMM_B)
5	RTC reset jumper (RTCST)
6	password jumper (PSWD)
7	chassis intrusion switch power connector (INTRUDER)
8	standby power indicator (12V_PWR)
9	battery (BATTERY)
10	fan shroud power connector (FAN1)
11	microprocessor heat sink

Microsoft® Windows® XP Features

Dell™ OptiPlex™ SX270 Systems User's Guide

- [Transferring Information to a New Computer](#)
 - [Using Windows® XP System Restore](#)
 - [User Accounts and Fast User Switching](#)
 - [Setting Up a Home and Office Network](#)
-

Transferring Information to a New Computer

The Microsoft® Windows® XP operating system provides a Files and Settings Transfer wizard to move data from the source computer to the new computer. You can move data such as:

- 1 E-mails
- 1 Toolbar settings
- 1 Window sizes
- 1 Internet bookmarks

You can transfer the data to the new computer over a network or serial connection, or you can store it on a removable medium, such as a writable CD or floppy disk.

To prepare the new computer for the file transfer:

1. Click the **Start** button, point to **All Programs**→**Accessories**→**System Tools**, and then click **Files and Settings Transfer Wizard**.
2. When the **Files and Settings Transfer Wizard** welcome screen appears, click **Next**.
3. On the **Which computer is this?** screen, click **New Computer** and click **Next**.
4. On the **Do you have a Windows XP CD?** screen, click **I will use the wizard from the Windows XP CD** and click **Next**.
5. When the **Now go to your old computer** screen appears, go to your old or source computer. *Do not* click **Next** at this time.

To copy data from the old computer:

1. On the old computer, insert the Windows XP *Operating System* CD.
2. On the **Welcome to Microsoft Windows XP** screen, click **Perform additional tasks**.
3. Under **What do you want to do?**, click **Transfer files and settings**.
4. On the **Files and Settings Transfer Wizard** welcome screen, click **Next**.
5. On the **Which computer is this?** screen, click **Old Computer** and click **Next**.
6. On the **Select a transfer method** screen, click the transfer method you prefer.
7. On the **What do you want to transfer?** screen, select the items you want to transfer and click **Next**.

After the information has been copied, the **Completing the Collection Phase** screen appears.

8. Click **Finish**.

To transfer data to the new computer:

1. On the **Now go to your old computer** screen on the new computer, click **Next**.
2. On the **Where are the files and settings?** screen, select the method you chose for transferring your settings and files and click **Next**.

The wizard reads the collected files and settings and applies them to your new computer.

When all of the settings and files have been applied, the **Finished** screen appears.

3. Click **Finished** and restart the new computer.
-

Using Windows® XP System Restore

The Microsoft® Windows XP operating system provides System Restore to allow you to return your computer to an earlier operating state (without affecting data files) if changes to the hardware, software, or other system settings have left the computer in an undesirable operating state. See the Windows Help and Support Center for information on using System Restore.

- **NOTICE:** Make regular backups of your data files. System Restore does not monitor your data files or recover them.

Creating a Restore Point

1. Click the **Start** button and click **Help and Support**.
2. Click **System Restore**.
3. Follow the instructions on the screen.

Restoring the Computer to an Earlier Operating State

 **NOTICE:** Before you restore the computer to an earlier operating state, save and close any open files and exit any open programs. Do not alter, open, or delete any files or programs until the system restoration is complete.

1. Click the **Start** button, point to **All Programs**→**Accessories**→**System Tools**, and then click **System Restore**.
2. Ensure that **Restore my computer to an earlier time** is selected and click **Next**.
3. Click a calendar date to which you want to restore your computer.

The **Select a Restore Point** screen provides a calendar that allows you to see and select restore points. All calendar dates with available restore points appear in boldface type.

4. Select a restore point and click **Next**.

If a calendar date has only one restore point, then that restore point is automatically selected. If two or more restore points are available, click the restore point that you prefer.

5. Click **Next**.

The **Restoration Complete** screen appears after System Restore finishes collecting data and then the computer restarts.

6. After the computer restarts, click **OK**.

To change the restore point, you can either repeat the steps using a different restore point, or you can undo the restoration.

Undoing the Last System Restore

 **NOTICE:** Before you undo the last system restore, save and close all open files and exit any open programs. Do not alter, open, or delete any files or programs until the system restoration is complete.

1. Click the **Start** button, point to **All Programs**→**Accessories**→**System Tools**, and then click **System Restore**.
2. Click **Undo my last restoration** and click **Next**.
3. Click **Next**.

The System Restore screen appears and the computer restarts.

4. After the computer restarts, click **OK**.

Enabling System Restore

If you reinstall Windows XP with less than 200 MB of free hard-disk space available, System Restore is automatically disabled. To see if System Restore is enabled:

1. Click the **Start** button and click **Control Panel**.
2. Click **Performance and Maintenance**.
3. Click **System**.
4. Click the **System Restore** tab.
5. Ensure that **Turn off System Restore** is unchecked.

User Accounts and Fast User Switching

Adding User Accounts

After the Microsoft® Windows® XP operating system is installed, the administrator or a user with administrator rights can create additional user accounts.

1. Click the **Start** button and click **Control Panel**.
2. In the **Control Panel** window, click **User Accounts**.
3. Under **Pick a task**, click **Create a new account**.
4. Under **Name the new account**, type the name of the new user and click **Next**.
5. Under **Pick an account type**, click one of the following options:
 1. **Computer administrator** — You can change all computer settings.

1. **Limited** — You can change only your own personal settings, such as your password. You cannot install programs or use the Internet.
6. Click **Create Account**.

Fast User Switching

 **NOTE:** Fast User Switching is unavailable if your computer is running Windows XP Professional and is a member of a computer domain, or if your computer has less than 128 MB of memory.

Fast User Switching allows multiple users to access one computer without requiring the previous user to log off.

1. Click the **Start** button and click **Log Off**.
2. In the **Log Off Windows** window, click **Switch User**.

When you use Fast User Switching, programs that previous users were using remain running in the background, so your computer might run slower. Also, multimedia programs, such as games and DVD software, might not work with Fast User Switching. For more information, see the Windows Help and Support Center.

Setting Up a Home and Office Network

Connecting to a Network Adapter

Before you connect your computer to a network, the computer must have a network adapter installed and a network cable connected to it.

To connect a network cable:

 **NOTE:** Insert the cable until it clicks into place, and then gently pull it to ensure that it is secure.

1. Connect the network cable to the network adapter connector on the back of your computer.

 **NOTE:** Do not use a network cable with a telephone wall jack.

2. Connect the other end of the network cable to a network connection device, such as a network wall jack.

Network Setup Wizard

The Microsoft® Windows® XP operating system provides a Network Setup Wizard to guide you through the process of sharing files, printers, or an Internet connection between computers in a home or small office.

1. Click the **Start** button, point to **All Programs**→**Accessories**→**Communications**, and then click **Network Setup Wizard**.
2. On the welcome screen, click **Next**.
3. Click **Checklist for creating a network**.

 **NOTE:** Selecting the connection method **This computer connects directly to the Internet** enables the integrated firewall provided with Windows XP.

4. Complete the checklist and required preparations.
 5. Return to the Network Setup Wizard and follow the instructions on the screen.
-

[Back to Contents Page](#)